



# Hahn Produktkatalog

**F** Catalogue produits

**GB** Product catalogue





## HAHN KT-RKV



### DESCRIPTION

The Hahn KT-RKV is fastened with screws in the rebate as is common for butt hinges. Depending on the design of the profile sections, 3-piece hinges are able to support doors weighing up to 120 kg. Both series can be adjusted in six directions with the door leaf installed: Door leaves can be adjusted vertically  $\pm 3$  mm and horizontal  $\pm 3$  mm as well and the sealing pressure by  $\pm 1$  mm

The mounting and removing of the door leaf is particularly easy and convenient with the 3-piece hinges. The upper hinge part can be easily mounted and removed in any position without having to loosen the fastening screws. Consequently, the door is mounted as with the 2-piece version and only then connected again and secured with the upper hinge part. An important advantage for installation personnel on the building site.

- Areas of application:  
Doors made of PVC sections, suited for both residential and commercial structures
  - Main entrance doors
  - Side entrance doors
  - Entrance doors for flats
  - Functional doors, e. g., emergency exit doors
- No lateral misalignment
- Door hinges are largely pre-assembled



### SYSTEM / APPLICATION

- Material: Constructed of extruded aluminium
- Fastening method: Directly mounted in frame and groove
- Euro-Groove versions 16 mm, 20 mm, 24 mm
- Load capacity:  
Depending on profile section design max. 120 kg
- Adjustability: Door leaf adjustable in six directions
  - Horizontal adjustment variable  $\pm 3$  mm
  - Height adjustment, variable up to  $\pm 3$  mm
  - Adjustment of sealing pressure variable  $\pm 1$  mm
- Certifications: CE certified according to EN1935:2002, hinge class 11
- Colours:  
Hinges available in EV1 and RAL colours
- Allows door to open up 180°
- Usable DIN left / DIN right
- Bearing point is maintenance-free



# KLEINES ROLLENBAND FÜR KUNSTSTOFFTÜREN

Paumelle cylindrique harmonieuse pour porte PVC  
Small „Rollenband“ for PVC doors



Bestell-Schlüssel / Art.-Nr. · Codes clés / No. d'article · Order key / item number

- 1** = EV1 schwarze Kunststoffteile / Pièces PVC noires / Black PVC parts
- G** = RAL 9016 weiße Kunststoffteile / Pièces PVC blanches / White PVC parts
- 9** = Sonderfarbe schwarze Kunststoffteile / Teinte spéciale pièces PVC noires / Custom colours black PVC parts

Bei Schlüsselziffer 9 bitte Sonderfarbe benennen. Beispiel: RAL 9005 Tiefschwarz.  
Pour le code teinte 9, veuillez indiquer la teinte spéciale. Exemple : RAL 9005 noir foncé.  
If you select No. 9, please indicate custom colour. Example: RAL 9005 jet black.

Verpackungseinheit: 1 Band im Karton / Unité d'emballage : 1 paumelle par boîte / Packaging unit: 1 hinge per box

16/3,0 mm und 16/3,5 mm Beschlagnut/  
Adapter mit langen Stiften

16/3,0 mm et 16/3,5 mm feuillure/  
Embase dormant avec tenons de centrage longs  
16/3.0 mm and 16/3.5 mm hinge groove/  
Adapter with long pins

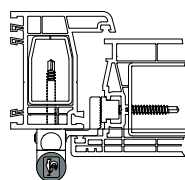

24/4,0 mm Beschlagnut/  
Adapter mit langen Stiften

24/4,0 mm feuillure/  
Embase dormant avec tenons de centrage longs  
24/4.0 mm hinge groove/  
Adapter with long pins

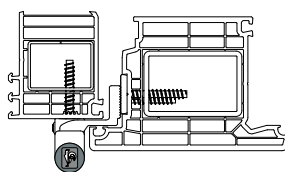

Verpackungseinheit: 24 Bänder im Karton / Unité d'emballage : 24 paumelles par boîte / Packaging unit: 24 hinges per box

16/3,0 mm und 16/3,5 mm Beschlagnut/  
Adapter mit langen Stiften

16/3,0 mm et 16/3,5 mm feuillure/  
Embase dormant avec tenons de centrage longs  
16/3.0 mm and 16/3.5 mm hinge groove/  
Adapter with long pins

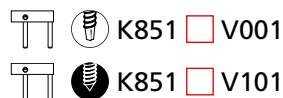
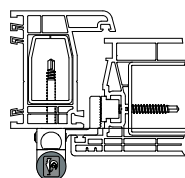

24/4,0 mm Beschlagnut/  
Adapter mit langen Stiften

24/4,0 mm feuillure/  
Embase dormant avec tenons de centrage longs  
24/4.0 mm hinge groove/  
Adapter with long pins

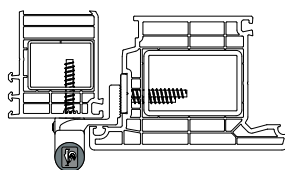

Adapter mit langen Stiften  
Embase dormant avec tenons  
de centrage longs  
Adapter with long pins



Selbstbohrende  
Schrauben  
Vis autoperforantes  
Self-tapping screws



Direktverschraubung  
Vissage direct  
Direct screw connection

Zubehör / Artikel-Nr. · Accessoires / No. d'article · Accessories / Item number

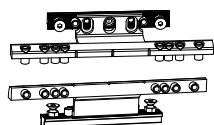

Bohrlehre  
Gabarit de perçage  
Drilling jig  
No. T318A0000

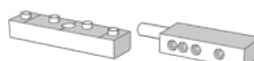

Bohrlehre für 24/4,0 mm Beschlagnut  
Gabarit de perçage pour feuillure 24/4,0 mm  
Drilling jig for 24/4.0 mm hinge groove  
No. T318A0001



KT-Senkkopfschraube 6,3x80 für Rahmen  
Vis à tête fraisée 6,3x80 pour dormant/  
Countersunk screw 6,3x80 for frame  
No. K500E0007

Technische Änderungen vorbehalten. Andere Farben auf Anfrage.  
Sous réserve de modifications techniques. Autres teintes sur demande.  
Right to alter technical details reserved. Other colours available on request.



# EINSTELLANLEITUNG

Notice de réglage  
Adjustment instructions



## Höhenverstellung · Réglage en hauteur · Adjusting the height

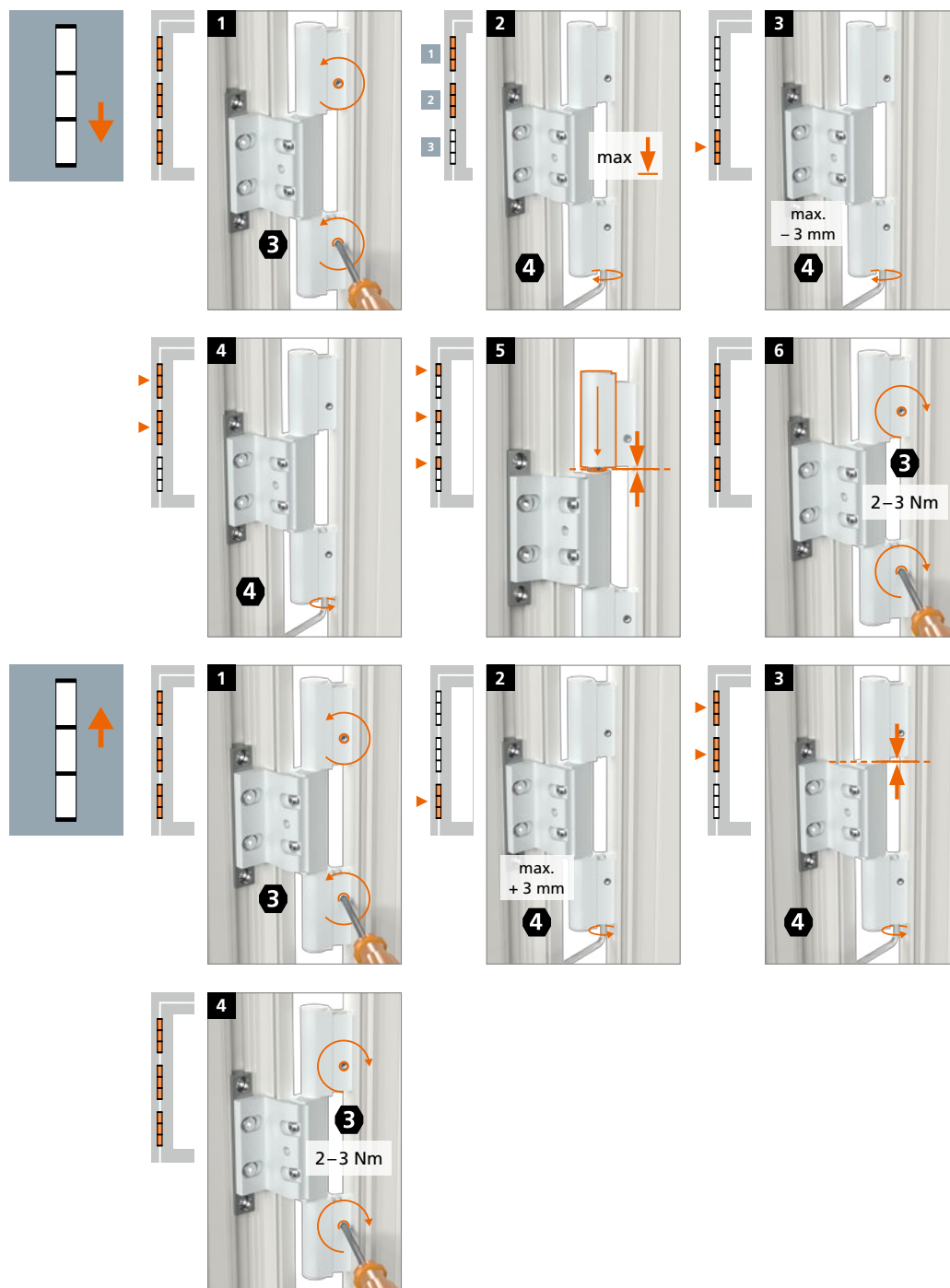



# EINSTELLANLEITUNG

Notice de réglage  
Adjustment instructions



## Horizontalverstellung · Réglage horizontal · Horizontal adjustment

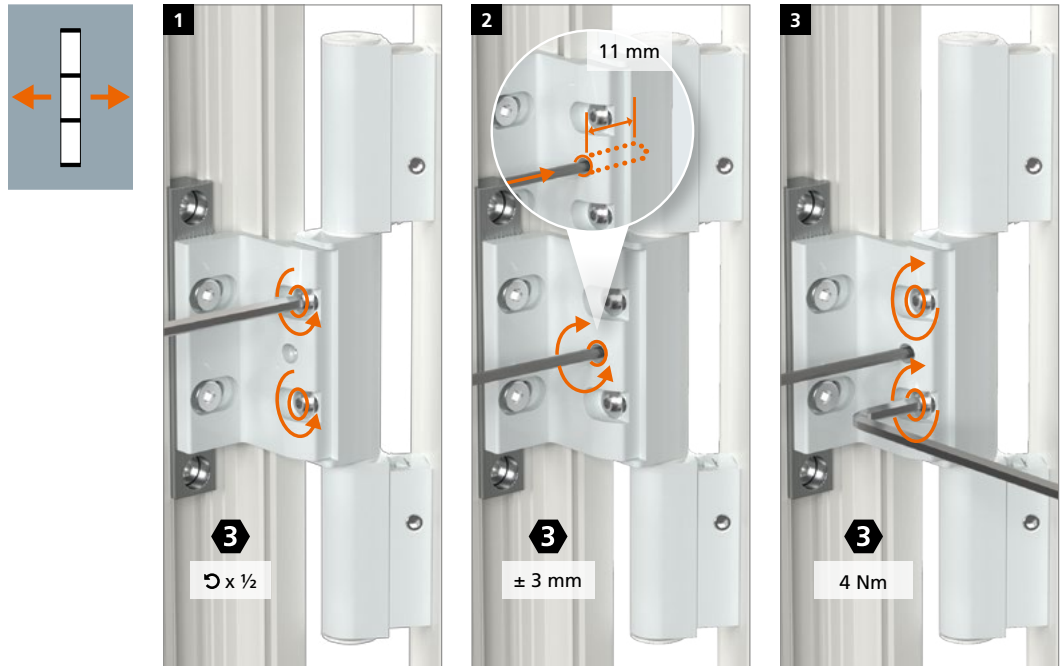

## Dichtungsandruckverstellung · Réglage de la compression du joint d'étanchéité · Adjusting the sealing pressure

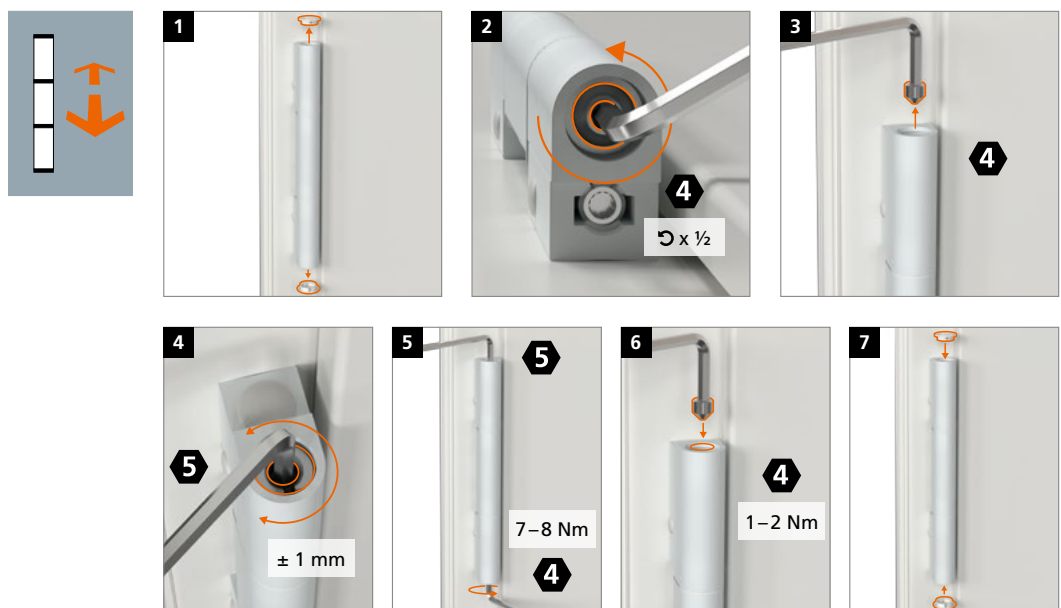



# EINSTELLANLEITUNG

Notice de réglage  
Adjustment instructions



Demontage an der Baustelle · Démontage sur le chantier · Disassembly on site

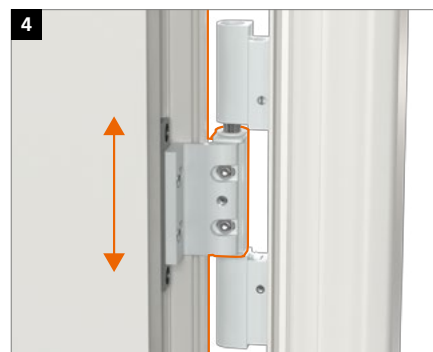
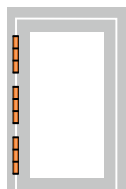



Hahn Serie 60 AT



Hahn KT-EV



Hahn VL-Band ST



Hahn Rollenband G



Hahn KT-RV



*Für jede  
Situation  
die passende  
Lösung*



Hahn KT-V 6R



Hahn VL-Band 180



Hahn Rollenband NG



Hahn KT-RN



Hahn Türband 4 AT



Hahn KT-Rollenband NL



Hahn KT-SV



Hahn KT-B 6R



Hahn Türband 4 AT



Hahn KT-N 6R



Hahn Türband 4 HM0



Hahn KT-RKN



Hahn KT-RV



Hahn KT-EN



Hahn Rollenband AT



Hahn Serie 60 AT



Hahn VL-Band AT



Hahn Klemmband



Hahn KT-RKV



Hahn Klemmband



Hahn AT-G



Hahn KT-RN

 **Dr. Hahn**<sup>®</sup>  
TÜRBÄNDER. MADE IN GERMANY.



**Dr. Hahn GmbH & Co. KG**

Trompeterallee 162-170 · D-41189 Mönchengladbach  
Postfach 400109 · D-41181 Mönchengladbach  
Phone +49(0)2166 954-3 · E-Mail: sales@dr-hahn.com  
[www.dr-hahn.eu](http://www.dr-hahn.eu)