

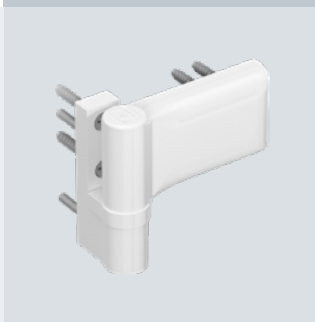

Hahn Produktkatalog

F Catalogue produits

GB Product catalogue

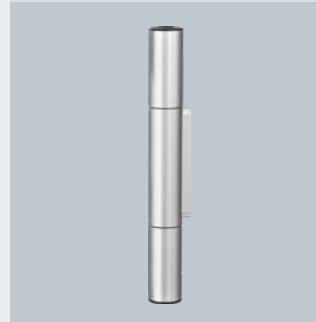
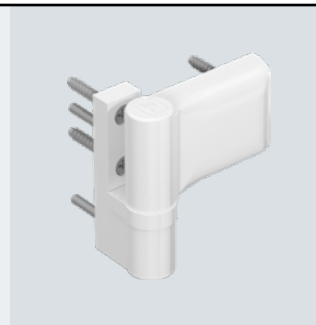



HAHN SERIE 60 AT



DESCRIPTION

NEW! HAHN SERIES 60 AT – ENSURING MAXIMUM FLEXIBILITY

The further development of the Hahn Series 60 AT has optimised and perfected the design. Thanks to the wide variety of mounting options, door installers are able to precisely match the hinge design to their installation situation. For instance, mounting plates are used for single chamber systems. For multiple chamber systems with a minimum wall thickness of 1.6 mm or more, the Hahn anchor screw is the method of choice.

Special requirements, for instance pressure-sensitive or veneered profile sections, can be ideally served with the Hahn screw anchor.

With the new design, door leaves can be moved horizontally by ± 2.5 mm due to structural changes. In terms of height, the hinge can also be adjusted by +3 mm and -2 mm. The most important achievement for door installers is that in most cases doors no longer have to be removed in order to adjust their sealing pressure.

- Areas of application:
Doors made of metal sections, suited for both residential and commercial structures
 - Main entrance doors
 - Side entrance doors
 - Functional doors
 - Interior doors
 - Exterior doors
 - Entrance doors for flats
- The hinge system offers a variety of possible combinations and mounting options for inward and outward opening doors with reversible profile and corner post construction.
- All metal parts of the hinge are protected against corrosion. Stainless steel version available for abnormally high loads.
- Special designs for folding doors and intrusion-resistant doors.
- Available for all common aluminium and steel profile sections.

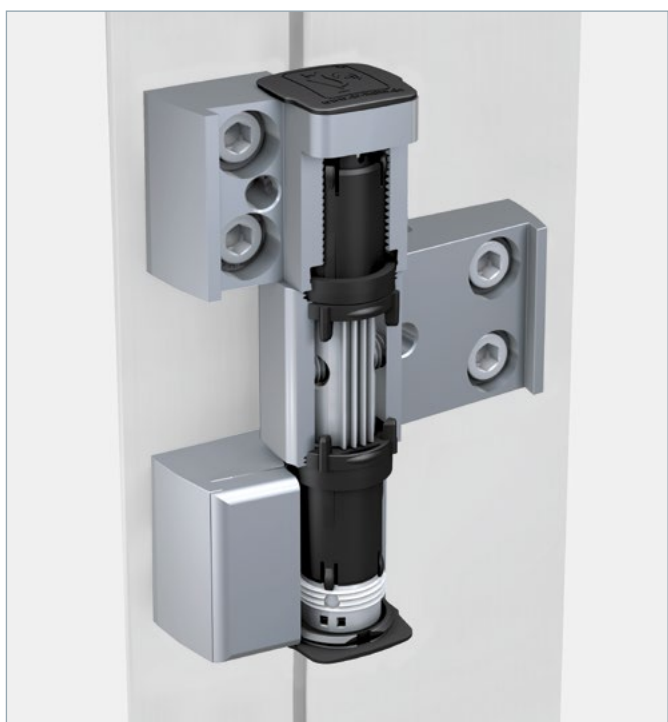

SYSTEM / APPLICATION

- Material: Made of extruded aluminium
- Fastening method: Fastening using anchor screws, screw anchors or mounting plates
- Versions: Two pivot points 20 and 36 mm
- Load capacity: Max. 220 kg depending on profile design
- Adjustability:
Adjustable in 6 directions with door leaf mounted:
 - Height adjustment using integrated lifting and lowering spindle, infinitely variable + 3 mm, - 2 mm
 - Horizontal adjustment, variable ± 2.5 mm
 - Sealing pressure ± 0.5 mm, individual variations require unhinging of leaf
- Usable DIN left / DIN right
- Certificates: · CE-certified according to EN1935:2002, hinge class 11/14
· SKG 2 stars
- Colours: Hinges available in anodised and RAL colours
- Allows doors to open up $> 180^\circ$
- Bearing point maintenance-free



Paumelle universelle pour portes métalliques
Universal hinge for metal doors



Bestell-Schlüssel / Art.-Nr. · Codes clés / No. d'article · Order key / item number

1 = EV1 **6** = RAL 9016 **R** = Elektrobraun matt · Brun électro satiné · Electro-coated in matt brown

9 = Sonderfarbe · Teinte spéciale · Custom colours

Schwarze Kunststoffteile / Pièces PVC noires / Black PVC parts

Bei Schlüsselziffer 9 bitte Sonderfarbe benennen. Beispiel: RAL 9005 Tiefschwarz.

Pour le code teinte 9, veuillez indiquer la teinte spéciale. Exemple : RAL 9005 noir foncé.

If you select No. 9, please indicate custom colour. Example: RAL 9005 jet black.

Befestigungsmittel
Fixation
Fastening elements

Ausführung Version Variation	Art.-Nr. No. d'article Item number	Ausführung Version Variation	Art.-Nr. No. d'article Item number
	M753 <input type="checkbox"/> E000		M754 <input type="checkbox"/> E000
	M751 <input type="checkbox"/> E000		M752 <input type="checkbox"/> E000
	M759 <input type="checkbox"/> E000		M760 <input type="checkbox"/> E000
	M757 <input type="checkbox"/> E000		M758 <input type="checkbox"/> E000
	M765 <input type="checkbox"/> E000		M766 <input type="checkbox"/> E000
	M763 <input type="checkbox"/> E000		M764 <input type="checkbox"/> E000
	M761 <input type="checkbox"/> E000		M762 <input type="checkbox"/> E000
	M783 <input type="checkbox"/> E000		

Technische Änderungen vorbehalten. Andere Oberflächen Ausführungen auf Anfrage.

Sous réserve de modifications techniques. Autres traitements de surface sur demande.

Right to alter technical details reserved. Types with different surfaces available on request.



Paumelle universelle pour portes métalliques
Universal hinge for metal doors



Bestell-Schlüssel / Art.-Nr. · Codes clés / No. d'article · Order key / item number

1 = EV1 **6** = RAL 9016 **R** = Elektrobraun matt · Brun électro satiné · Electro-coated in matt brown

9 = Sonderfarbe · Teinte spéciale · Custom colours

Schwarze Kunststoffteile / Pièces PVC noires / Black PVC parts

Bei Schlüsselziffer 9 bitte Sonderfarbe benennen. Beispiel: RAL 9005 Tiefschwarz.

Pour le code teinte 9, veuillez indiquer la teinte spéciale. Exemple : RAL 9005 noir foncé.

If you select No. 9, please indicate custom colour. Example: RAL 9005 jet black.

Ausführung Version Variation	Art.-Nr. No. d'article Item number	Ausführung Version Variation	Art.-Nr. No. d'article Item number
	M775 <input type="checkbox"/> E000		
	M755 <input type="checkbox"/> E000		M756 <input type="checkbox"/> E000
	M767 <input type="checkbox"/> E000		M768 <input type="checkbox"/> E000
	M769 <input type="checkbox"/> E000		M770 <input type="checkbox"/> E000
	M773 <input type="checkbox"/> E000		M774 <input type="checkbox"/> E000
	M771 <input type="checkbox"/> E000		M772 <input type="checkbox"/> E000
	M777 <input type="checkbox"/> E000		
	M781 <input type="checkbox"/> E000		

Technische Änderungen vorbehalten. Andere Oberflächenausführungen auf Anfrage.

Sous réserve de modifications techniques. Autres traitements de surface sur demande.

Right to alter technical details reserved. Types with different surfaces available on request.



Utilisations spéciales Special applications



Bestell-Schlüssel / Art.-Nr. · Codes clés / No. d'article · Order key / item number

1 = EV1 **6** = RAL 9016 **R** = Elektrobraun matt · Brun électro satiné · Electro-coated in matt brown

9 = Sonderfarbe · Teinte spéciale · Custom colours

Schwarze Kunststoffteile / Pièces PVC noires / Black PVC parts

Bei Schlüsselziffer 9 bitte Sonderfarbe benennen. Beispiel: RAL 9005 Tiefschwarz.

Pour le code teinte 9, veuillez indiquer la teinte spéciale. Exemple : RAL 9005 noir foncé.

If you select No. 9, please indicate custom colour. Example: RAL 9005 jet black.

Ausführung Version Variation	Art.-Nr. No. d'article Item number	Ausführung Version Variation	Art.-Nr. No. d'article Item number
	M785 <input type="checkbox"/> <input type="checkbox"/> <input type="checkbox"/> <input type="checkbox"/> <input type="checkbox"/>		M789 <input type="checkbox"/> <input type="checkbox"/> <input type="checkbox"/> <input type="checkbox"/> <input type="checkbox"/>
	M786 <input type="checkbox"/> <input type="checkbox"/> <input type="checkbox"/> <input type="checkbox"/> <input type="checkbox"/>		M790 <input type="checkbox"/> <input type="checkbox"/> <input type="checkbox"/> <input type="checkbox"/> <input type="checkbox"/>
	M788 <input type="checkbox"/> <input type="checkbox"/> <input type="checkbox"/> <input type="checkbox"/> <input type="checkbox"/>		M792 <input type="checkbox"/> <input type="checkbox"/> <input type="checkbox"/> <input type="checkbox"/> <input type="checkbox"/>
	M787 <input type="checkbox"/> <input type="checkbox"/> <input type="checkbox"/> <input type="checkbox"/> <input type="checkbox"/>		

Hinweis:

Bänder mit Halbmaß 5 werden grundsätzlich mit Befestigungsmittel geliefert.
Artikel-Nr. auf Anfrage.

Remarque :

Les paumelles avec une cote axe de perçage dormant de 5 seront en règle générale livrées avec des fixations.
Référence article sur demande.

Notice:

Hinges with a half dual spacing of 5 are generally supplied incl. fastening material.
Item no. available on request.

Hinweis:

Keine Anker-Schrauben-Befestigung möglich.

Remarque :

Pas de fixation par vis d'ancrage directe possible.

Notice:

Fastening via anchor screw impossible.



Utilisations spéciales / Accessoires
Special applications / Accessories

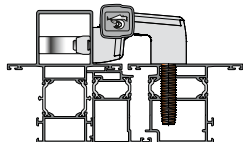

Bei Bestellung bitte Profilsystem und Profilkombination angeben.

En cas de commande, veuillez indiquer la gamme et la combinaison de profilés.

Please determine profile system and combination when ordering.

Eckpfosten-Konstruktion /
Construction d'angle /
Corner post construction

Zubehör · Accessoires · Accessories Artikel-Nr. · No. d'article · Item number

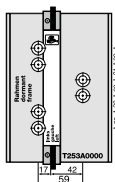

No. T253A0000

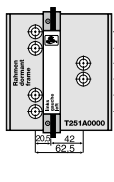

No. T251A0000

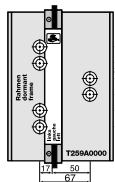

No. T259A0000

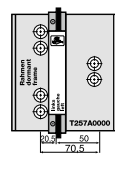

No. T257A0000

Bohrlehren
Gabarits de perçage
Drilling jigs

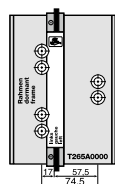

No. T265A0000

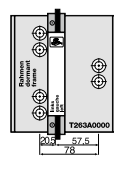

No. T263A0000

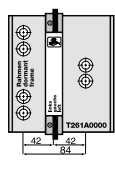

No. T261A0000

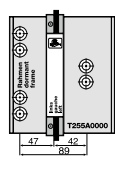

No. T255A0000

Bohrlehren
Gabarits de perçage
Drilling jigs

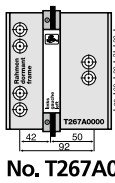

No. T267A0000

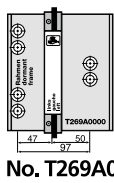

No. T269A0000

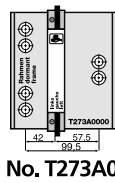

No. T273A0000

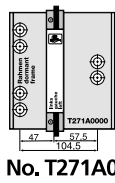

No. T271A0000

Bohrlehren
Gabarits de perçage
Drilling jigs

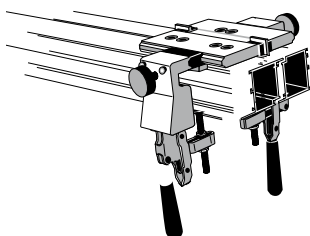

Nachrüst-Set
als Schnellspannbohrlehre
Set de serrage
pour gabarit à serrage rapide
Retrofit set
as rapid-clamping drilling jig
No. T150A0001

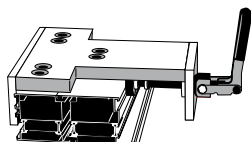

Bitte nehmen Sie zur Bestellung einer Schnellspannbohrlehre Kontakt mit uns auf.

Veuillez-nous contacter avant de commander un gabarit à serrage rapide.

Please contact us for ordering rapid-clamping drilling jigs.

Schnellspannbohrlehre
Gabarit à serrage rapide
Rapid-clamping drilling jig

Artikel-Nr. auf Anfrage
No. d'article sur demande
Item no. on request



Artikel-Nr. · No. d'article · Item number



Steckbohrbuchse / Douille guide foret / Slip-type drill bush

No. A650A0056 Ø 5 mm / Ø 11 mm

No. A650A0040 Ø 5 mm / Ø 15 mm



Stufenbohrer / Foret étagé / Step drill

Ø 6 mm / Ø 11 mm

No. A650A0035



Aushebewerkzeug / Outil d'extraction / Extraction tool

No. A850A0015

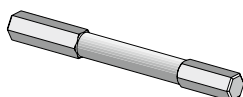

Schaft E 6,3 / Klinge SW6
Tige E 6,3 / lame SW 6
Shaft E 6.3 / Blade SW6

Spezialbit für Schraub-Anker und Befestigungsschrauben / Embout tournevis pour vis ancrage et vis de fixation / Special bit for screw anchors and fastening screws

No. A750A0027



Sicherungsstorn / Broche de blocage / Safety mandrel

No. A650A0017



Sicherungsstorn mit Kragen / Broche de blocage avec collette / Safety mandrel with collar

No. A850A0000



Verpackungseinheit 40 Kugeln, jeweils 2 im Spezialhalter.

Unité d'emballage de 40 billes, à raison de 2 dans support spécial.

Packing unit 40 balls, 2 each in special holder.

Kugeln / Billes / Balls

No. A850A0011



VE = 1 Abreißschraube, 4 Kugeln, 2 Spezialhalter
UV = 1 vis avec tête s'arrachant, 4 billes, 2 support spécial
PU = 1 snap-off screw, 4 balls, 2 special holder

Sicherheitsset (für 3-teilige Bänder) / Kit de sécurité (pour paumelles 3 lames) / Security set (for three-piece hinges)



VE = 24 Stück
UE = 24 pièces
PU = 24 pieces

Sägeschutz-Lagerbolzen
Axe anti-sciage
Saw-resistant bearing pin

No. M750A0024



Notice de réglage Adjustment instructions



Dichtungsdruck verstellen · Réglage de la pression du joint · Adjusting the sealing pressure

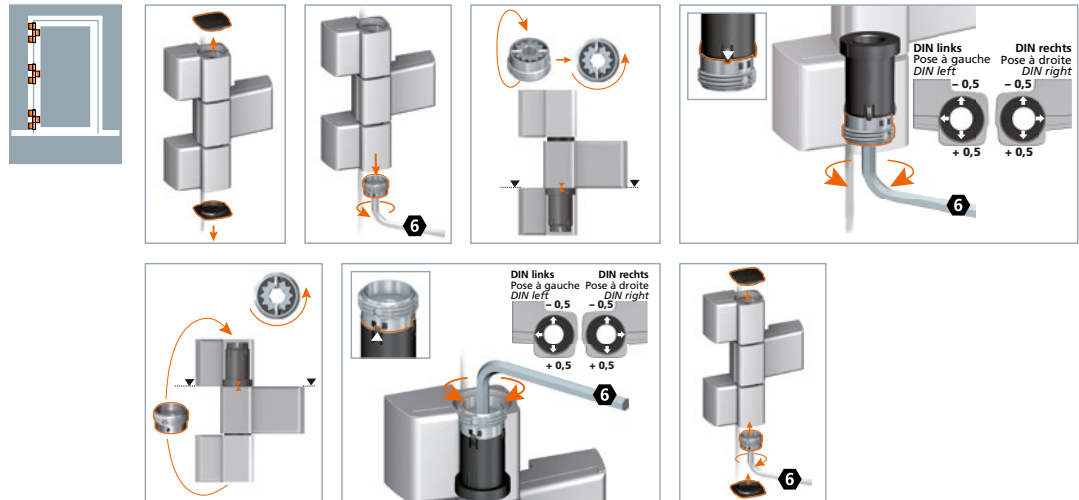

Horizontalverstellung · Réglage horizontal · Horizontal adjustment

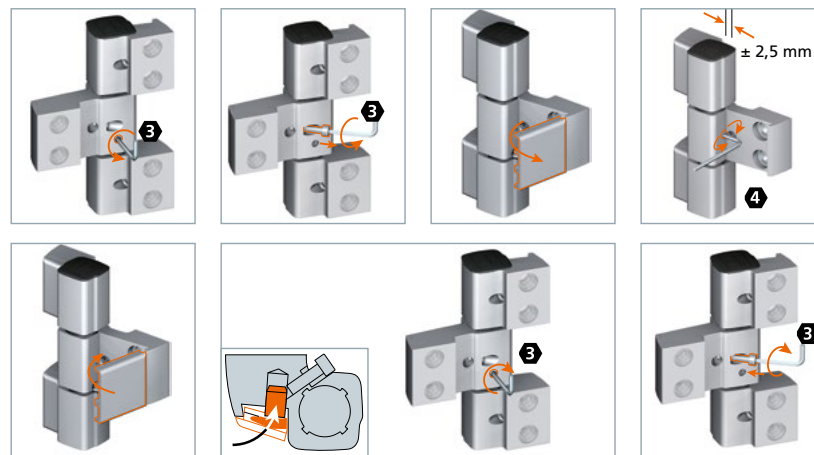

Höhenverstellung · Réglage en hauteur · Height adjustment

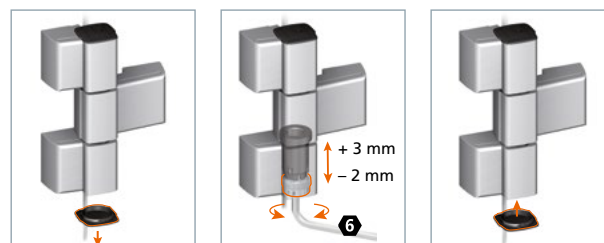



Hahn Serie 60 AT



Hahn KT-EV



Hahn VL-Band ST



Hahn Rollenband G



Hahn KT-RV



*Für jede
Situation
die passende
Lösung*



Hahn KT-V 6R



Hahn VL-Band 180



Hahn Rollenband NG



Hahn KT-RN



Hahn Türband 4 AT



Hahn KT-Rollenband NL



Hahn KT-SV



Hahn KT-B 6R



Hahn Türband 4 AT



Hahn KT-N 6R



Hahn Türband 4 HM0



Hahn KT-RKN



Hahn KT-RV



Hahn KT-EN



Hahn Rollenband AT



Hahn Serie 60 AT



Hahn VL-Band AT



Hahn Klemmband



Hahn KT-RKV



Hahn Klemmband



Hahn AT-G



Hahn KT-RN

 **Dr. Hahn**[®]
TÜRBÄNDER. MADE IN GERMANY.



Dr. Hahn GmbH & Co. KG

Trompeterallee 162-170 · D-41189 Mönchengladbach
Postfach 400109 · D-41181 Mönchengladbach
Phone +49(0)2166 954-3 · E-Mail: sales@dr-hahn.com
www.dr-hahn.eu