



Hahn Produktkatalog

F Catalogue produits

GB Product catalogue





HAHN TÜR BAND 4 AT



DESCRIPTION

GOOD MADE EVEN BETTER

Dr. Hahn has further optimised the flagship product of its hinge range, especially some of its key functions. In addition, details were incorporated into the design to make handling even more efficient in the workshop and on the building site. Thanks to the sophisticated distribution of the forces occurring, Türband 4 AT is significantly more stable at the hinge after horizontal adjustment. Alignment has become easier too, even with high loads.

A new feature in the series is the half measure zero, where the frame hinge blade has been reduced to the minimum space required. This new variation is used especially in situations, where there is only a small amount of space on the frame side.

In addition to that, Türband 4 AT also has a new geometry, which ensures a particularly tight fit of the caps.

- Areas of application:
Doors made from metal profiles, in particular in the property real-estate and quality residential housing construction
 - Main entrance doors
 - Side entrance doors
 - Functional doors
 - Interior doors
 - Exterior doors
- The hinge system offers a variety of possible combinations and mounting options for inward and outward opening doors with reversible profile and corner post construction
- All metal parts of the hinge are protected against corrosion. Stainless steel design available for abnormal stress
- Special design for anti-intruder doors
- Available for all major aluminium and steel sections



SYSTEM / APPLICATION

- Material: Made of extruded aluminium
- Fastening method: Fastened using anchor screws, screw anchors or mounting plates with fastening screws
- Versions: two pivot points of 20 mm and 36 mm
Half measure 0, pivot 22 mm
Further additional pivots upon request
- Load capacity: Max. 180 kg depending on profile design
- Adjustability:
Fitted door leaf is adjustable in 6 directions:
 - Height adjustment infinitely variable via integrated lifting spindle + 3 mm, - 2 mm
 - Horizontal adjustment infinitely variable ± 2.5 mm
 - Sealing contact pressure ± 0.5 mm, individual variants require lifting of the leaf
- Usable DIN left / DIN right
- Certifications: · CE-certified according to EN1935:2002, hinge class 14
· SKG 3 stars
- Colours:
Hinges available in anodised colours and RAL colours
- Opening angle 180°
- Bearing point is maintenance-free



Paumelle universelle pour portes haut de gamme
Universal hinge for functional doors



Bestell-Schlüssel / Art.-Nr. · Codes clés / No. d'article · Order key / item number

Weißer Kunststoffteile / Pièces PVC blanches / White PVC parts

B = EV1 **G** = RAL 9016

Schwarze Kunststoffteile / Pièces PVC noires / Black PVC parts

1 = EV1

R = Elektrobraun matt /

Brun électro satiné / Electro-coated in matt brown

9 = Sonderfarbe / Teinte spéciale / Custom colours

Bei Schlüsselziffer 9 bitte Sonderfarbe benennen.

Beispiel: RAL 9005 Tiefschwarz. / Pour le code teinte 9, veuillez indiquer la teinte spéciale. Exemple : RAL 9005 noir foncé. / If you select No. 9, please indicate custom colour. Example: RAL 9005 jet black.

Beispiel / Exemple / Example:

M901 **B** **T** 000 → EV1, 48 mm, Stahl / Acier / Steel

K = 37,5 mm, Stahl / Acier / Steel,

19,5 mm Nutzlänge / longueur utile / effective length

L = 37,5 mm, Niro / Inox / Stainless steel,

19,5 mm Nutzlänge / longueur utile / effective length

T = 48 mm, Stahl / Acier / Steel,

30 mm Nutzlänge / longueur utile / effective length

V = 48 mm, Niro / Inox / Stainless steel,

30 mm Nutzlänge / longueur utile / effective length

W = 58 mm, Stahl / Acier / Steel,

40 mm Nutzlänge / longueur utile / effective length

Y = 58 mm, Niro / Inox / Stainless steel,

40 mm Nutzlänge / longueur utile / effective length

S = 58 mm, für Stahlprofile / Pour profils en acier / For steel profiles,

40 mm Nutzlänge / longueur utile / effective length

M = 74 mm, Stahl / Acier / Steel,

56 mm Nutzlänge / longueur utile / effective length

N = 74 mm, Niro / Inox / Stainless steel,

56 mm Nutzlänge / longueur utile / effective length

	<p>I M903 <input type="checkbox"/> <input type="checkbox"/> 000</p> <p>15 M903 <input type="checkbox"/> 0000</p> <p>21 M903 <input type="checkbox"/> 0001</p>		<p>I M904 <input type="checkbox"/> <input type="checkbox"/> 000</p> <p>15 M904 <input type="checkbox"/> 0000</p> <p>21 M904 <input type="checkbox"/> 0001</p>
	<p>I M901 <input type="checkbox"/> <input type="checkbox"/> 000</p> <p>15 M901 <input type="checkbox"/> 0000</p> <p>21 M901 <input type="checkbox"/> 0001</p>		<p>I M902 <input type="checkbox"/> <input type="checkbox"/> 000</p> <p>15 M902 <input type="checkbox"/> 0000</p> <p>21 M902 <input type="checkbox"/> 0001</p>
	<p>I M915 <input type="checkbox"/> <input type="checkbox"/> 000</p> <p>15 M915 <input type="checkbox"/> 0000</p> <p>21 M915 <input type="checkbox"/> 0001</p>		<p>I M916 <input type="checkbox"/> <input type="checkbox"/> 000</p> <p>15 M916 <input type="checkbox"/> 0000</p> <p>21 M916 <input type="checkbox"/> 0001</p>
	<p>I M913 <input type="checkbox"/> <input type="checkbox"/> 000</p> <p>15 M913 <input type="checkbox"/> 0000</p> <p>21 M913 <input type="checkbox"/> 0001</p>		<p>I M914 <input type="checkbox"/> <input type="checkbox"/> 000</p> <p>15 M914 <input type="checkbox"/> 0000</p> <p>21 M914 <input type="checkbox"/> 0001</p>
	<p>I M931 <input type="checkbox"/> <input type="checkbox"/> 000</p> <p>15 M931 <input type="checkbox"/> 0000</p> <p>21 M931 <input type="checkbox"/> 0001</p>		<p>I M932 <input type="checkbox"/> <input type="checkbox"/> 000</p> <p>15 M932 <input type="checkbox"/> 0000</p> <p>21 M932 <input type="checkbox"/> 0001</p>
	<p>I M925 <input type="checkbox"/> <input type="checkbox"/> 000</p> <p>15 M925 <input type="checkbox"/> 0000</p> <p>21 M925 <input type="checkbox"/> 0001</p>		<p>I M926 <input type="checkbox"/> <input type="checkbox"/> 000</p> <p>15 M926 <input type="checkbox"/> 0000</p> <p>21 M926 <input type="checkbox"/> 0001</p>



Anker-Schraube
 Vis d'ancrage directe
 Anchor screw



Befestigungsplatten
 15 mm + 21 mm
 Contreplaques
 15 mm + 21 mm
 Mounting plates
 15 mm + 21 mm

Technische Änderungen vorbehalten. Andere Oberflächenausführungen auf Anfrage.
 Sous réserve de modifications techniques. Autres traitements de surface sur demande.
 Right to alter technical details reserved. Types with different surfaces available on request.



Paumelle universelle pour portes haut de gamme
Universal hinge for functional doors



Bestell-Schlüssel / Art.-Nr. · Codes clés / No. d'article · Order key / item number

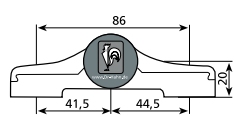

- I** M911 000
- 15** M911 0000
- 21** M911 0001

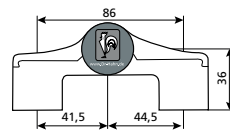

- I** M912 000
- 15** M912 0000
- 21** M912 0001

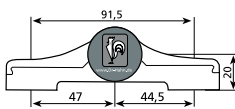

- I** M905 000
- 15** M905 0000
- 21** M905 0001

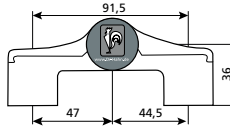

- I** M906 000
- 15** M906 0000
- 21** M906 0001

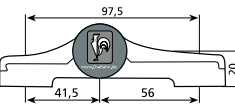

- I** M923 000
- 15** M923 0000
- 21** M923 0001

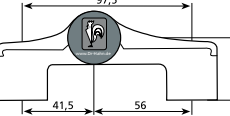

- I** M924 000
- 15** M924 0000
- 21** M924 0001

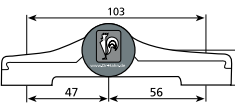

- I** M921 000
- 15** M921 0000
- 21** M921 0001

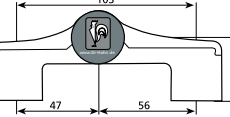

- I** M922 000
- 15** M922 0000
- 21** M922 0001

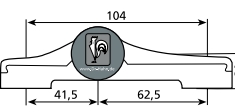

- I** M927 000
- 15** M927 0000
- 21** M927 0001

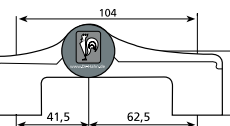

- I** M928 000
- 15** M928 0000
- 21** M928 0001

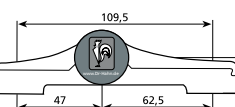

- I** M929 000
- 15** M929 0000
- 21** M929 0001

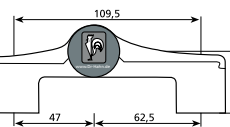

- I** M930 000
- 15** M930 0000
- 21** M930 0001

Für Aluminiumprofile
 Pour profils en aluminium
 For aluminium profiles



Für Stahlprofile
 Pour profils en acier
 For steel profiles



Halbmaß 0, Drehpunkt 22 mm. Weitere Drehpunkte auf Anfrage.
 Cote axe dormant 0, axe de rotation 22 mm. Autres axes de rotation sur demande.
 Half measure 0, pivot 22 mm. Further additional pivots upon request.

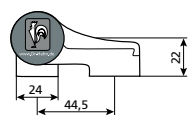

- I** M933 000
- 15** M933 0000
- 21** M933 0001

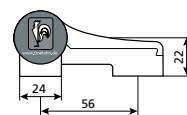

- I** M935 000
- 15** M935 0000
- 21** M935 0001

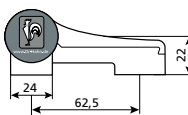

- I** M937 000
- 15** M937 0000
- 21** M937 0001

Technische Änderungen vorbehalten. Andere Oberflächen Ausführungen auf Anfrage.
 Sous réserve de modifications techniques. Autres traitements de surface sur demande.
 Right to alter technical details reserved. Types with different surfaces available on request.



Artikel-Nr. · No. d'article · Item number

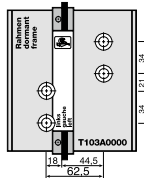

No. T103A0000

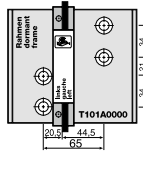

No. T101A0000

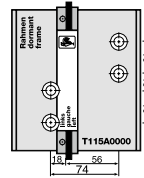

No. T115A0000

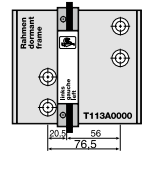

No. T113A0000

Bohrlehren
Gabarits de perçage
Drilling jigs

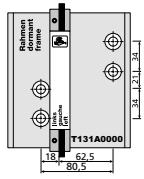

No. T131A0000

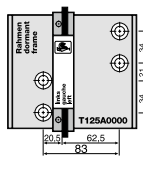

No. T125A0000

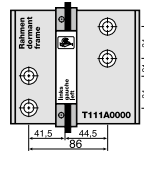

No. T111A0000

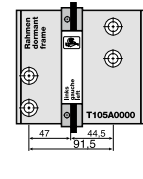

No. T105A0000

Bohrlehren
Gabarits de perçage
Drilling jigs

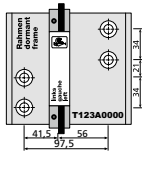

No. T123A0000

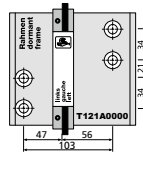

No. T121A0000

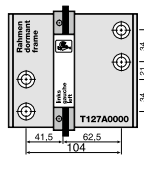

No. T127A0000

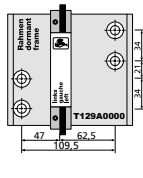

No. T129A0000

Bohrlehren
Gabarits de perçage
Drilling jigs

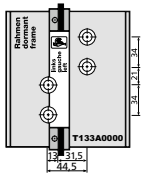

No. T133A0000

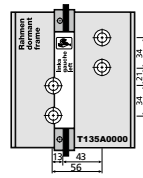

No. T135A0000

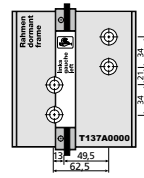

No. T137A0000

Bohrlehren
Gabarits de perçage
Drilling jigs

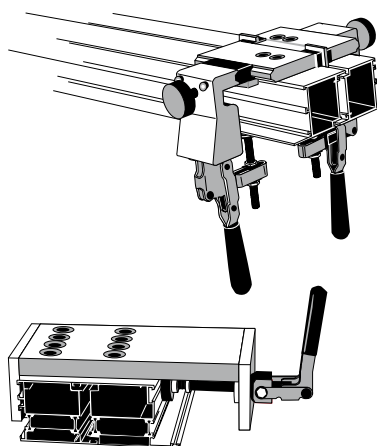

Nachrüst-Set
als Schnellspannbohrlehre
Set de serrage
pour gabarit à serrage rapide
Retrofit set
as rapid-clamping drilling jig
No. T150A0001

Bitte nehmen Sie zur Bestellung
einer Schnellspannbohrlehre
Kontakt mit uns auf.

Veuillez-nous contacter avant de
commander un gabarit à serrage
rapide.

Please contact us for ordering rapid-
clamping drilling jigs.

Schnellspannbohrlehre
Gabarit à serrage rapide
Rapid-clamping drilling jig

Artikel-Nr. auf Anfrage
No. d'article sur demande
Item no. on request



Accessoires
Accessories



Artikel-Nr. · No. d'article · Item number



**Steckbohrbuchse /
Douille guide foret /
Slip-type drill bush**
Ø 5 mm / Ø 11 mm
No. A650A0056



**Stufenbohrer / Foret étagé /
Step drill**
Ø 6 mm / Ø 11 mm
No. A650A0035

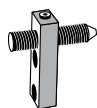

**Sicherungsdorn /
Broche de blocage /
Safety mandrel**
No. A650A0017

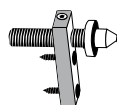

**Sicherungsdorn mit Kragen /
Broche de blocage avec colle-
rette / Safety mandrel with collar**
No. A850A0000



Verpackungseinheit 40 Kugeln,
jeweils 2 im Spezialhalter.
Unité d'emballage de 40 billes,
à raison de 2 dans support spécial.
Packing unit 40 balls, 2 each
in special holder.

Kugeln / Billes / Balls
No. A950A0011



VE = 24 Stück
UE = 24 pièces
PU = 24 pieces

**Sägeschutz-Lagerbolzen
Axe anti-sciage
Saw-resistant bearing pin**
No. M950A0001

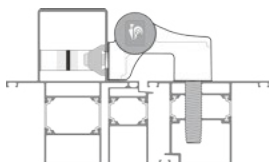

Bei Bestellung bitte Profilsystem und
Profilkombination angeben.
En cas de commande, veuillez indiquer
la gamme et la combinaison de profils.
Please determine profile system and
combination when ordering.

**Eckpfosten-Konstruktion /
Construction d'angle /
Corner post construction**



Notice de réglage
Adjustment instructions



Dichtungsdruck verstellen · Régler la pression du joint d'étanchéité · Adjusting the sealing pressure

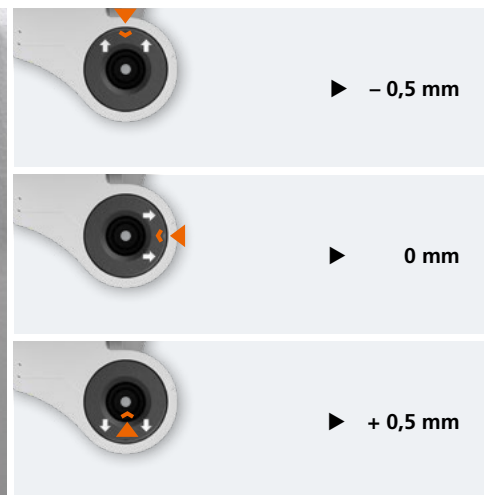
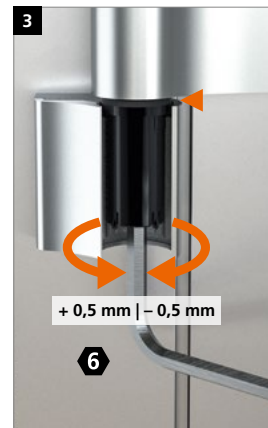
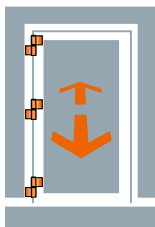



Höhenverstellung · Réglage en hauteur · Adjusting the height

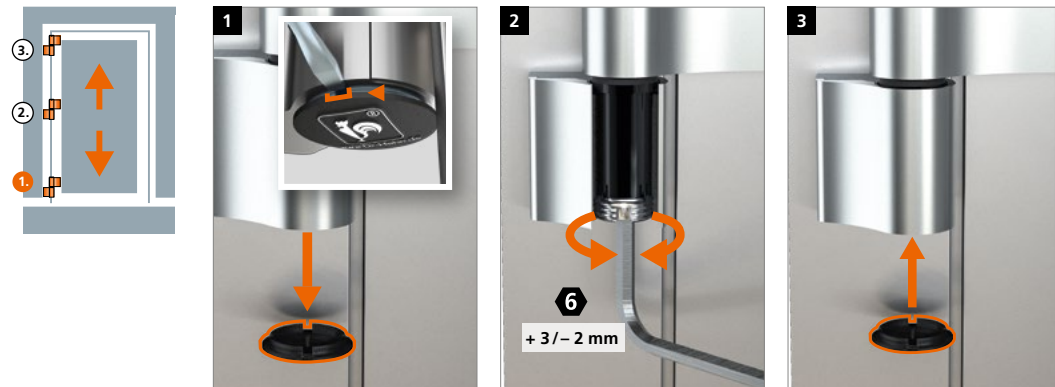

Horizontalverstellung · Réglage horizontal · Horizontal adjustment



Lagerbuchse aus wartungsfreiem Kunststoff – **keinesfalls schmieren!**
Douille en matière plastique ne requérant aucun entretien – **ne graisser en aucun cas !**
Bearing bushes made of maintenance-free PVC – **do not lubricate!**



Hahn Serie 60 AT



Hahn KT-EV



Hahn VL-Band ST



Hahn Rollenband G



Hahn KT-RV



*Für jede
Situation
die passende
Lösung*



Hahn KT-V 6R



Hahn VL-Band 180



Hahn Rollenband NG



Hahn KT-RN



Hahn Türband 4 AT



Hahn KT-Rollenband NL



Hahn KT-SV



Hahn KT-B 6R



Hahn Türband 4 AT



Hahn KT-N 6R



Hahn Türband 4 HM0



Hahn KT-RKN



Hahn KT-RV



Hahn KT-EN



Hahn Rollenband AT



Hahn Serie 60 AT



Hahn VL-Band AT



Hahn Klemmband



Hahn KT-RKV



Hahn Klemmband



Hahn AT-G



Hahn KT-RN

 **Dr. Hahn**[®]
TÜRBÄNDER. MADE IN GERMANY.



Dr. Hahn GmbH & Co. KG

Trompeterallee 162 – 170 · D-41189 Mönchengladbach
Postfach 400109 · D-41181 Mönchengladbach
Phone +49(0)2166 954-3 · E-Mail: sales@dr-hahn.com
www.dr-hahn.eu