



Hahn Türband 4 AT



- + Quick
- + Strong
- + Secure



Hinge system for wood/aluminium doors



Only 3 steps
for easy installation!

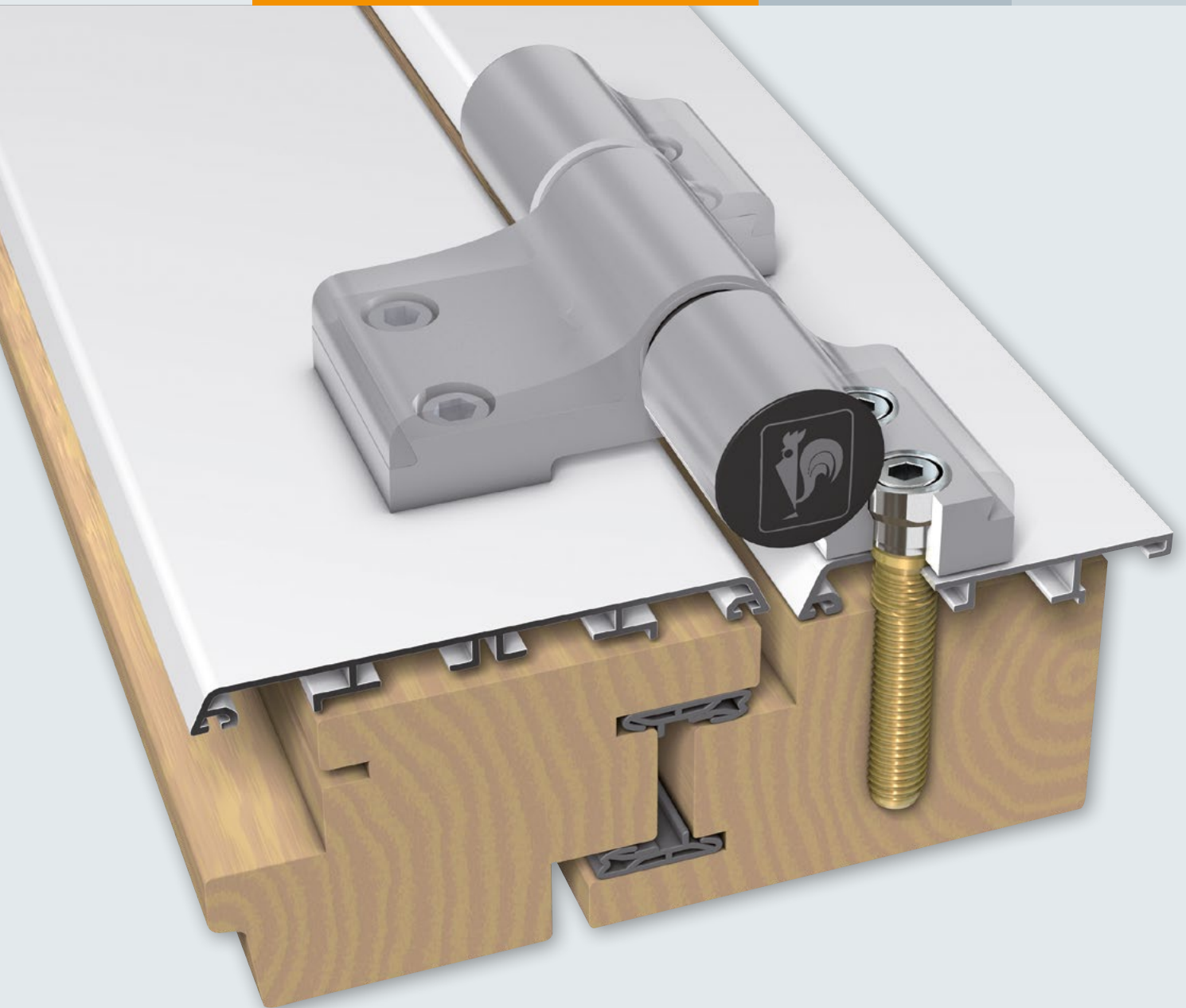

The new installation process with the Hahn screw anchor only requires three steps: drill, screw in, and screw on

- Very fast process
- No need to remove the aluminium shell
- No shims required
- Adjustable in six directions – without having to lift or remove the door leaf
- A subsequent installation of additional hinges possible without much effort – even in precisely fitted frames
- Select the colour which optimally matches the aluminium shell from the entire RAL range of colours
- Usable on all aluminium shells



Hahn Türband 4 AT

For wood/
aluminium doors

Areas of use

Residential doors made of wood and combined wood/aluminium constructions

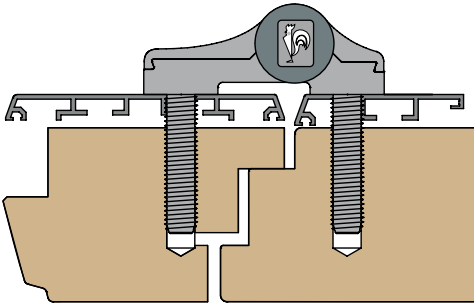

Easy to adjust

- **Horizontal adjustment**
stepless ± 2.5 mm
– for quicker processing
- **Height adjustment**
stepless $+3/-2$ mm – without lifting or removing the door
- **Adjustment of sealing pressure**
 ± 0.5 mm with door leaf installed

Other advantages:

- Dimensionally stable and colour-fast PVC parts for long-lasting attractive look
- Solid hinges with elegant design – appear light on the door
- Continuous bearing pins made of stainless steel – for outstanding hinge stability
- Bearing point maintenance-free, no lubrication required
- Covers that snap in place – with integrated lock screw
- Innovative fastening with Hahn screw anchor
- Door adjustment by only one person

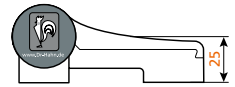

18.0	44.5 mm
18.0	56.0 mm
20.5	44.5 mm
20.5	56.0 mm
18.0	62.5 mm
20.5	62.5 mm
41.5	44.5 mm
41.5	56.0 mm
41.5	62.5 mm
47.0	44.5 mm
47.0	56.0 mm
47.0	62.5 mm
0	44.5 mm
0	56 mm
0	62.5 mm

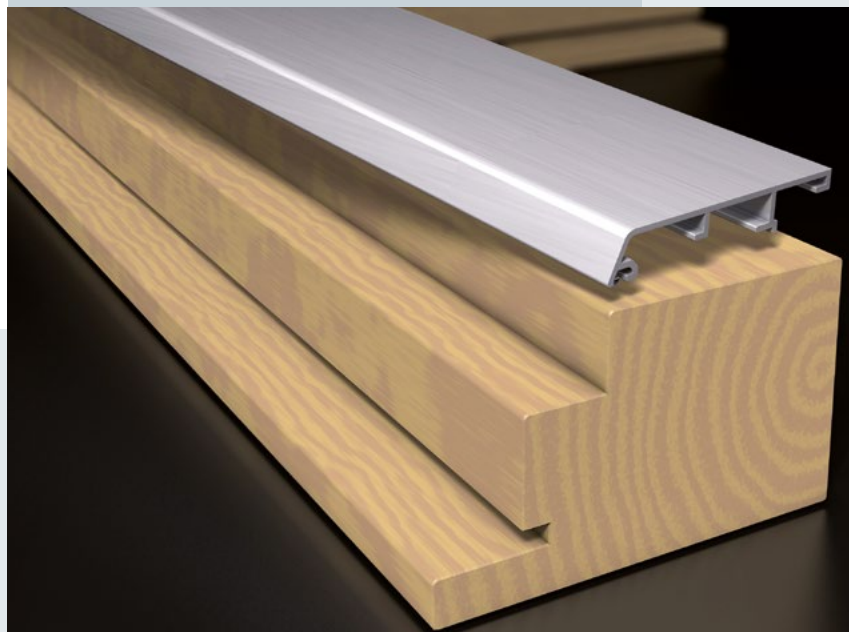

Installation / adjustment instructions

Installing the hinge

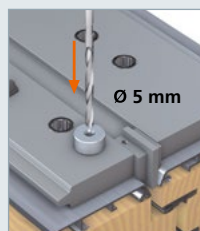

Optional:
Pre-drilling with Hahn slip-type jig bush No. A650A0056.

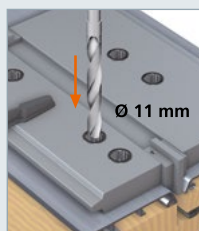

Drill 11 mm diameter holes.

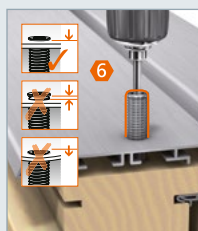

Screw-in screw anchor until flush with surface.

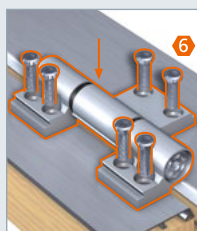

Secure hinges with screws in the internal threads of the screw anchor (20 – 25 Nm).



Screw-in lifting and lowering spindle.

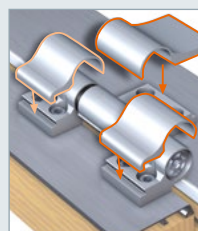

Screw-in lifting and lowering spindle.

Adjusting the sealing pressure



± 0.5 mm

Horizontal adjustment



± 2.5 mm

Height adjustment



+ 3/- 2 mm

Accessories

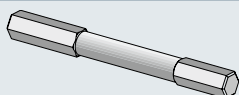

Special bit for screw anchors and fastening screws
shaft E 6.3/blade SW6
No. A750A0027



Slip-type jig bush
No. A650A0056 Ø 5 mm/Ø 11 mm



Step drill bit
No. A650A0035 Ø 6 mm/Ø 11 mm



Drill bit
No. K450A0001 Ø 5 mm

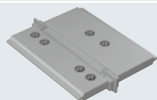

Drill bit available on request



Saw-resistant bearing pin
No. M950A0000 PU=24 pieces

