



Hahn KT-N 6R / KT-V 6R



New upstand 20–25 mm





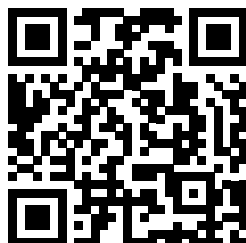







Universal hinges for PVC-U doors



KT-FIX!



								
	Service classes	Durability	Weight of test door	Fire resistance	Security	Corrosion resistance	Intrusion protection	Hinge class
	4	7	7	0	1	0/4 (5)*	1	14
	4	7	7	0	1	0/4 (5)*	1	14

Suitable for use on emergency exit doors. *Corrosion class 5 in accordance with DIN EN 1670:2007
 Class 0 = uncoated/non-anodised door hinges, Class 4 = high corrosion resistance
 Class 5 = very high corrosion resistance

CE For explanations of the table, please visit www.dr-hahn.com





Hahn KT-N 6R / KT-V 6R

Universal hinges
for PVC-U doors

- 1 **KT-N 6R with retaining angle** for additional stability
- 2 **Quick installation** – zero position predefined in as-delivered condition
- 3 **Good weathering resistance** due to modern PVC-U
- 4 **Horizontal adjustment ± 5 mm**
Inaccessible for unauthorised persons
- 5 **Variable adjustment of sealing pressure** by means of Hahn toothed bushing ± 2.5 mm + 0.5 mm reserve within the upstand range
- 6 **Contemporary design** due to subtle contours
- 7 **Flawless appearance** – bushing collar covers all adjustment gaps
- 8 **SKG-certified security** – integrated bolt security without additional parts
- 9 **Height adjustment variable from the zero position:**
raising + 4 mm
lowering – 3 mm

Other advantages

- Six possible adjustments which can be carried out single-handedly without raising or removing the door
- CE-certified with hinge class 14 for very high loads
- Supports 160 kg, depending on profile section design
- High surface quality available in all RAL colours and special designs
- Five upstand ranges: 15 – 20 mm, 16,5 – 21,5 mm, 18 – 23 mm, 20 – 25 mm, 22 – 27 mm
- Good fit even with very high heat insulating chambers, due to extended centring pins
- Bearing bolt can be removed with door mounted, e.g. with low lintel

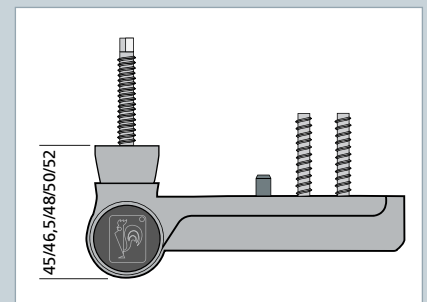
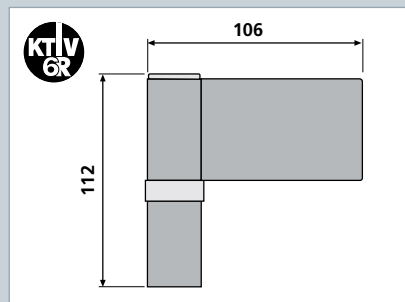
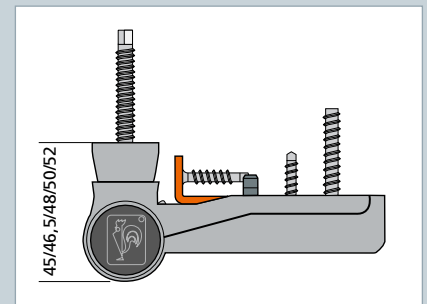
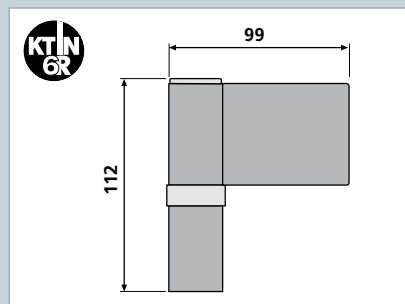

New design – with proven flexibility

Proven products with improved technology and fresh design:

The Hahn KT-N 6R und KT-V 6R premium hinges accentuate the beauty of attractive doors with their subtle design and stand out due to their efficient, high-calibre installation technology.

Both series achieved hinge class 14 rating for very high loads during testing for CE labeling and thus may also be installed on emergency exit doors. A good fit is also ensured even with doors that have high heat insulating chambers. The hinges of both series are tested and approved for doors weighing up to 160 kg, depending on the design of door frame.

All adjustments can be performed on site by one person without having to raise or remove the door. As tried, tested and proven in real world use, the hinges of the series Hahn KT-N 6R and Hahn KT-V 6R can be adjusted variably in six directions.

Installation instructions

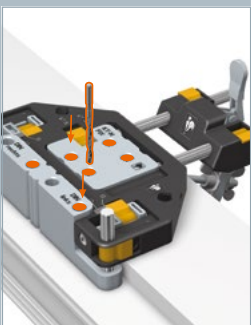

Drill holes in frame and door. Note left or right-hand doors.

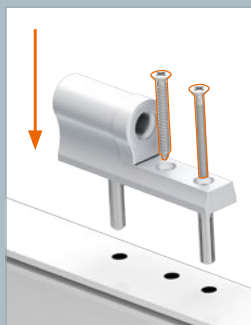

Install frame hinge part and screw down (pre-assembled).



Insert bearing element for left-hand or right-hand doors.

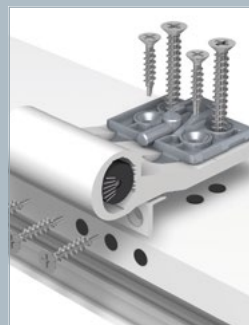

Screw on hinge part for door.

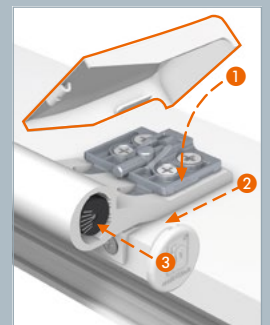

Insert caps.



Adjustment instructions

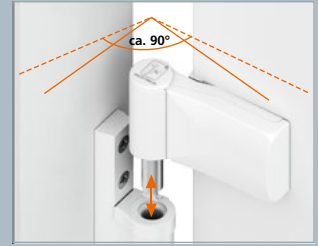

Mounting and removing the door while open 90°. If necessary, knock out bolt.



Variable adjustment of sealing pressure.

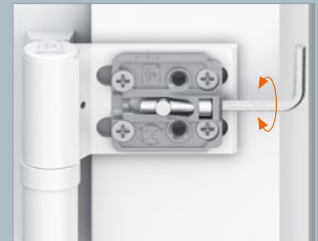

Horizontal adjustment, infinitely variable up to ± 5 mm.



Height adjustment variable from the zero position.
Raising + 4 mm, Lowering – 3 mm

Attractive – secure – sturdy

Front entrance doors are usually selected with care and based on individual requirements. After all, they serve as the calling card of a building for many years. In addition to reliability, particular emphasis is also placed on protection against break-ins. KT-N 6R and KT-V 6R series hinges have proven that they are secure in the demanding tests of SKG.

Bearing bushing and bolt element are combined into a sturdy unit thanks to a newly developed type of bolt. The bolt is protected against unauthorised tampering when the door is closed without requiring any extra measures. Shape and colour can either make the hinge disappear or act as an attractive design element, depending on individual desires.

All RAL colours and several individual metallic tones are available for every door, ensuring you find what you are looking for. The new cover strip results in a uniform colour scheme of all components.





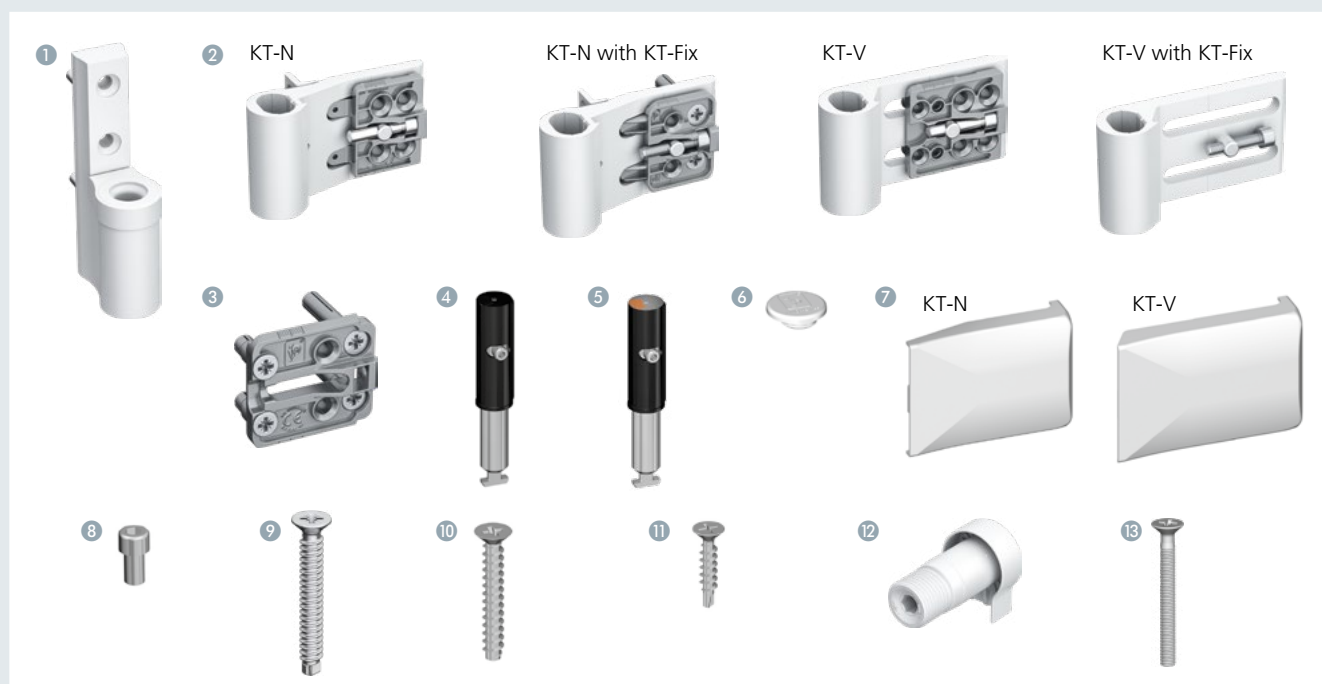









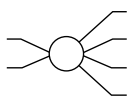

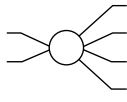

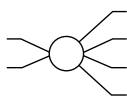

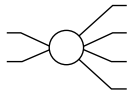

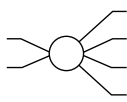
Accessories and individual parts

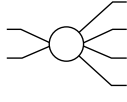

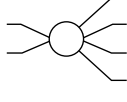
1	Frame hinge part including bearing bushing white (pls indicate RAL colour)		KT-N/KT-V	Item number available on request
1	Frame hinge part including bearing bushing black (pls indicate RAL colour)		KT-N/KT-V	Item number available on request
2	Door hinge part (pls indicate RAL colour)		KT-N KT-V KT-N KT-V	No. K400B0044 No. K500B0002 No. K400B0093 No. K500B0010
3	Fastening component KT-V FIX, complete		KT-V	No. K500B0011
4	Bearing bolt, complete		KT-N/KT-V	No. K400B0047
5	Saw-resistant bearing bolt, complete		KT-N/KT-V	No. K400B0131
6	Cap		white black KT-N/KT-V KT-N/KT-V	No. K400K0023 No. K400K0024
7	Cover strip (pls indicate RAL colour)		KT-N KT-V	No. K400G0008 No. K500G0004
8	Locking screw for cover strip (small)		KT-N/KT-V	No. E3300802
9	Self-drilling screw 6,3 x 49		KT-N/KT-V	No. K400E0041
10	Countersunk head tapping screw 6x40		KT-N/KT-V	No. EF9000521
11	Self-drilling screw for upstand fastening		KT-N	No. E3300803
12	Bearing bushing with lifting spindle		white black KT-N/KT-V KT-N/KT-V	No. K400B0151 No. K400B0150
13	Countersunk screw 5 x 50		KT-N/KT-V	No. K400E0034

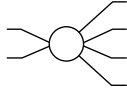
Drilling jig without clamp		KT-N KT-V KT-N KT-V	Nr. T316A0000 Nr. T315A0000 Nr. T316A0F02 Nr. T315A0F02
Drilling jig with clamp		KT-N KT-V KT-N KT-V	Nr. T316A0001 Nr. T315A0001 Nr. T316A0F03 Nr. T315A0F03
Automatic rod drilling jig for direct screw connection		KT-N KT-V KT-N KT-V	Nr. T416A0001 Nr. T415A0001 Nr. T416A0F03 Nr. T415A0F03
Step screw with flat-headed screw M6x18		KT-N/KT-V	Nr. K450A0006
Tool for screwing in step screw		KT-N/KT-V	Nr. K450A0004

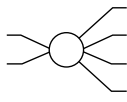
Packing unit

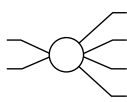
Packing unit 1 hinge per box					
Upstand range 17.5 mm (15 – 20 mm)	 P470 ■ 0000 P470 ■ 0F00	 P570 ■ 0000 P570 ■ 0F00		E RAL 9010 G RAL 9016 5 RAL 8077 9 Special colour*	
Upstand range 19 mm (16.5 – 21.5 mm)	 P475 ■ 0000 P475 ■ 0F00	 P575 ■ 0000 P575 ■ 0F00		E RAL 9010 G RAL 9016 5 RAL 8077 9 Special colour*	
Upstand range 20.5 mm (18 – 23 mm)	 P480 ■ 0000 P480 ■ 0F00	 P580 ■ 0000 P580 ■ 0F00		E RAL 9010 G RAL 9016 5 RAL 8077 9 Special colour*	
Upstand range 22.5 mm (20 – 25 mm)	 P485 ■ 0000 P485 ■ 0F00	 P585 ■ 0000 P585 ■ 0F00		E RAL 9010 G RAL 9016 5 RAL 8077 9 Special colour*	
Upstand range 24.5 mm (22 – 27 mm)	 P490 ■ 0000 P490 ■ 0F00	 P590 ■ 0000 P590 ■ 0F00		E RAL 9010 G RAL 9016 5 RAL 8077 9 Special colour*	
Packing unit 24 hinges per box					
Upstand range 17.5 mm (15 – 20 mm)	 P470 ■ V000 P470 ■ VF00	 P570 ■ V000 P570 ■ VF00		E RAL 9010 G RAL 9016 5 RAL 8077 9 Special colour*	
Upstand range 19 mm (16.5 – 21.5 mm)	 P475 ■ V000 P475 ■ VF00	 P575 ■ V000 P575 ■ VF00		E RAL 9010 G RAL 9016 5 RAL 8077 9 Special colour*	
Upstand range 20.5 mm (18 – 23 mm)	 P480 ■ V000 P480 ■ VF00	 P580 ■ V000 P580 ■ VF00		E RAL 9010 G RAL 9016 5 RAL 8077 9 Special colour*	
Upstand range 22.5 mm (20 – 25 mm)	 P485 ■ V000 P485 ■ VF00	 P585 ■ V000 P585 ■ VF00		E RAL 9010 G RAL 9016 5 RAL 8077 9 Special colour*	
Upstand range 24.5 mm (22 – 27 mm)	 P490 ■ V000 P490 ■ VF00	 P590 ■ V000 P590 ■ VF00		E RAL 9010 G RAL 9016 5 RAL 8077 9 Special colour*	



 Direct installation with screws

 KT-FIX fastening system

*Please indicate special colour (e.g. Inox N)

 **Dr. Hahn**[®]
HINGES. MADE IN GERMANY.



Dr. Hahn GmbH & Co. KG

Trompeterallee 162 – 170 · D-41189 Mönchengladbach
Postfach 400109 · D-41181 Mönchengladbach
Phone +49(0)2166 954-3 · E-Mail: sales@dr-hahn.com
www.dr-hahn.com