

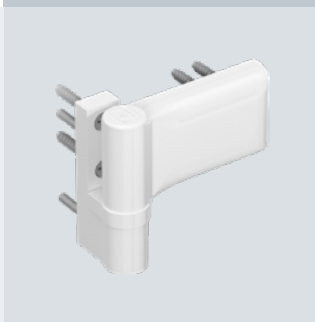

Hahn Produktkatalog

F Catalogue produits

GB Product catalogue

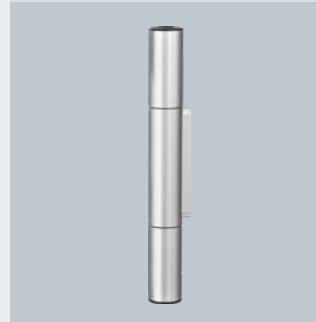
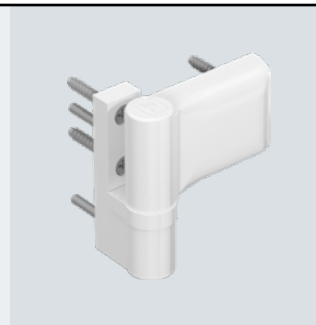



HAHN KT-RKN



BESCHREIBUNG

Das 3-teilige Hahn KT-RKN trägt Flügelgewicht bis zu 120 Kg – je nach Ausführung der Profile. Mit seiner 18 mm Bandrolle ist es dabei ausgesprochen filigran am Element. Es passt auf alle gängigen Profilsysteme. Um einen möglichst hohen Formschluss zu erreichen, gibt es das KT-RKN mit Flügelbandteilen für eine rechtwinklige Anbindung (0°) und mit leicht abgeschrägter Anbindung (5°). So entsteht ein vielfältiger Bausatz, aus dem der Türenbauer das für seine Anforderungen passende Rollenband auswählen kann. Es können Aufdeckungssituationen von 16,5 mm – 26 mm bedient werden. Eine universell einsetzbare Bohrlehre erleichtert dem Türenbauer in der Werkstatt die Arbeit.

Das Ein- und Aushängen des Türflügels ist besonders komfortabel. Ein Bandteil kann nämlich in jeder Lage einfach aufgesteckt und abgezogen werden, ohne Befestigungsschrauben zu lösen.

Beim Hahn KT-RKN bleibt die Dichtung immer intakt. Die Tür bewahrt so ihre maximale Eigenschaft zur Dämmung von Wärme, Wind und Feuchtigkeit.

- Einsatzgebiete:
 - Türen aus Kunststoffprofilen, gleichermaßen im Wohnungs- und Objektbau
 - Haupteingangstüren
 - Nebeneingangstüren
 - Wohnungsabschlusstüren
 - Funktionstüren, z. B. Fluchtwegstüren
- Kein seitlicher Rollenversatz
- Türbänder sind weitestgehend vormontiert



TECHNIK / ANWENDUNG

- Material: Gefertigt aus stranggepresstem Aluminium
- Befestigungsart: Direktverschraubung in Rahmen und Aufdeck
- Ausführungen: Aufdeckbereich ab 16,5 mm
- Belastbarkeit:
 - In Abhängigkeit der Profilausführung max. 120 kg
- Verstellbarkeit: Türflügel in 6 Richtungen verstellbar
 - Horizontalverstellung stufenlos ± 3 mm
 - Höhenverstellung stufenlos ± 3 mm
 - Dichtungsdruckverstellung stufenlos ± 1 mm
- Zertifikate: CE-zertifiziert gemäß EN 1935:2002, Bandklasse 13
- Farbausführungen:
 - Bänder in Silber EV1 und RAL-Farben lieferbar
- Öffnungswinkel bis zu 180°
- DIN links/DIN rechts verwendbar
- Lagerstelle wartungsfrei



KLEINES ROLLENBAND FÜR KUNSTSTOFFTÜREN

Paumelle cylindrique harmonieuse pour porte PVC
Small „Rollenband“ for PVC doors



Bestell-Schlüssel/Art.-Nr. · Codes clés/No. d'article · Order key/item number

- 1** = EV1 schwarze Kunststoffteile / Pièces PVC noires / Black PVC parts
- G** = RAL 9016 weiße Kunststoffteile / Pièces PVC blanches / White PVC parts
- 9** = Sonderfarbe schwarze Kunststoffteile / Teinte spéciale pièces PVC noires / Custom colours black PVC parts

Bei Schlüsselziffer 9 bitte Sonderfarbe benennen. Beispiel: RAL 9005 Tiefschwarz.
Pour le code teinte 9, veuillez indiquer la teinte spéciale. Exemple : RAL 9005 noir foncé.
If you select No. 9, please indicate custom colour. Example: RAL 9005 jet black.

Verpackungseinheit: 1 Band im Karton / Unité d'emballage : 1 paumelle par boîte / Packaging unit: 1 hinge per box

Flügelanbindung 0° / Adapter mit langen Stiften
Chant d'ouvrant 0° /
Embase dormant avec tenons de centrage longs
Door connection 0° / Adapter with long pins

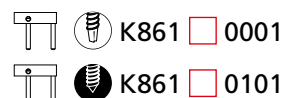
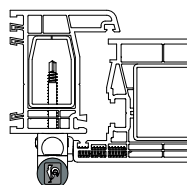

Flügelanbindung 5° / Adapter mit langen Stiften
Chant d'ouvrant 5° /
Embase dormant avec tenons de centrage longs
Door connection 5° / Adapter with long pins

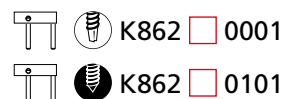
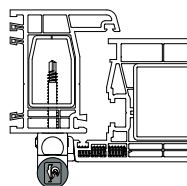

Verpackungseinheit: 24 Bänder im Karton / Unité d'emballage : 24 paumelles par boîte / Packaging unit: 24 hinges per box

Flügelanbindung 0° / Adapter mit langen Stiften
Chant d'ouvrant 0° /
Embase dormant avec tenons de centrage longs
Door connection 0° / Adapter with long pins

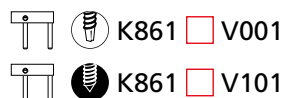
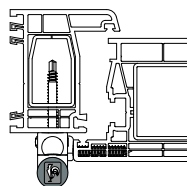

Flügelanbindung 5° / Adapter mit langen Stiften
Chant d'ouvrant 5° /
Embase dormant avec tenons de centrage longs
Door connection 5° / Adapter with long pins

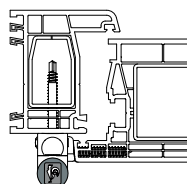

Adapter mit langen Stiften
Embase dormant avec tenons de centrage longs
Adapter with long pins



Selbstbohrende
Schrauben
Vis autoperforantes
Self-tapping screws



Direktverschraubung
Vissage direct
Direct screw connection

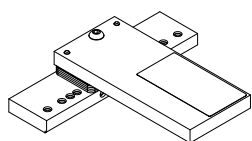

Bohrlehre
Gabarit de perçage
Drilling jig
No. T317A0000



KT-Senkkopfschraube 6,3x80 für Rahmen/
Vis à tête fraisée 6,3x80 pour dormant/
Countersunk screw 6,3x80 for frame
No. K500E0007

Technische Änderungen vorbehalten. Andere Farben auf Anfrage.
Sous réserve de modifications techniques. Autres teintes sur demande.
Right to alter technical details reserved. Other colours available on request.

Zubehör/Artikel-Nr. · Accessoires/No. d'article · Accessories/Item number



EINSTELLANLEITUNG

Notice de réglage
Adjustment instructions



Höhenverstellung · Réglage en hauteur · Adjusting the height

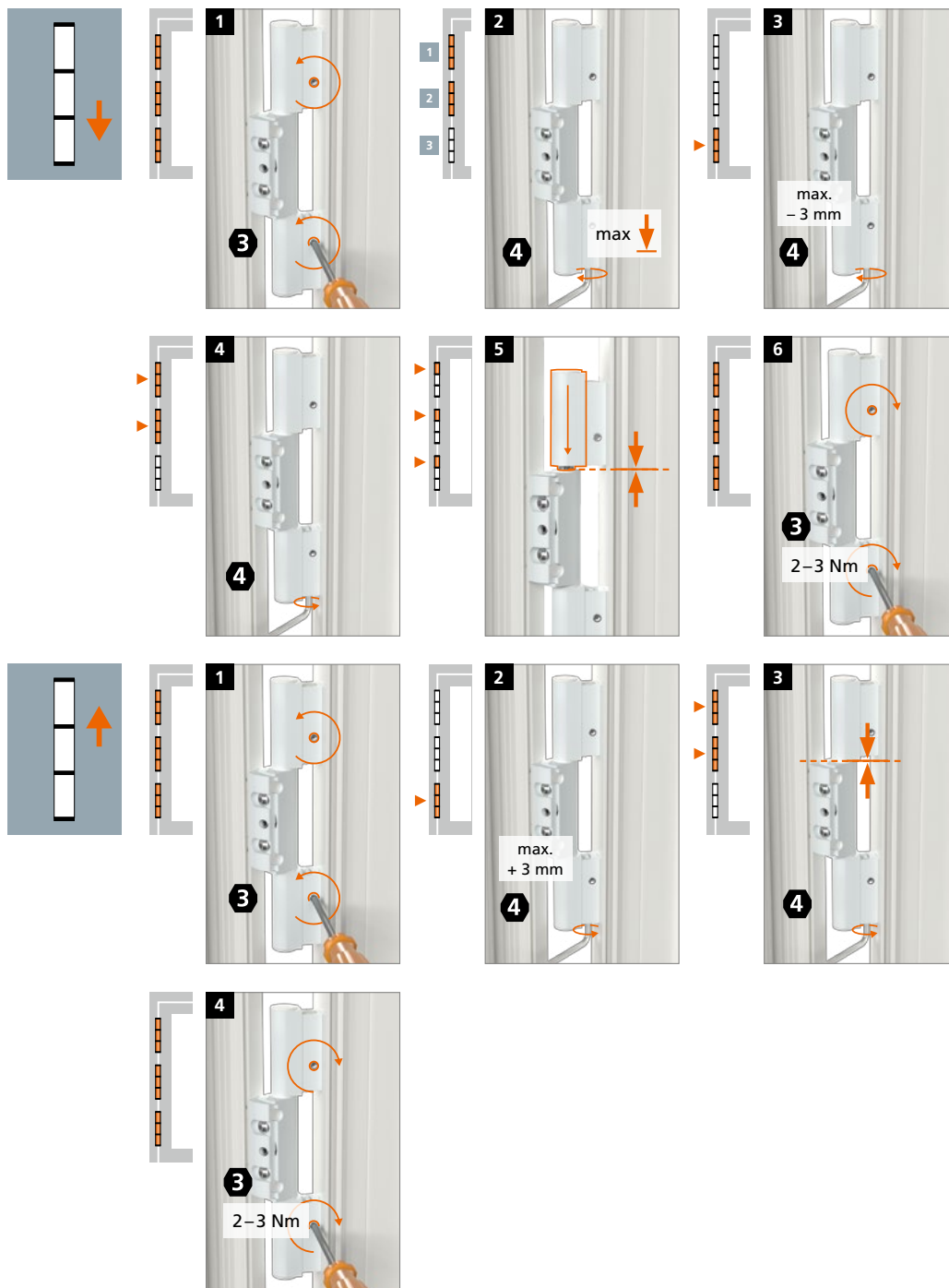



EINSTELLANLEITUNG

Notice de réglage
Adjustment instructions



Horizontalverstellung · Réglage horizontal · Horizontal adjustment

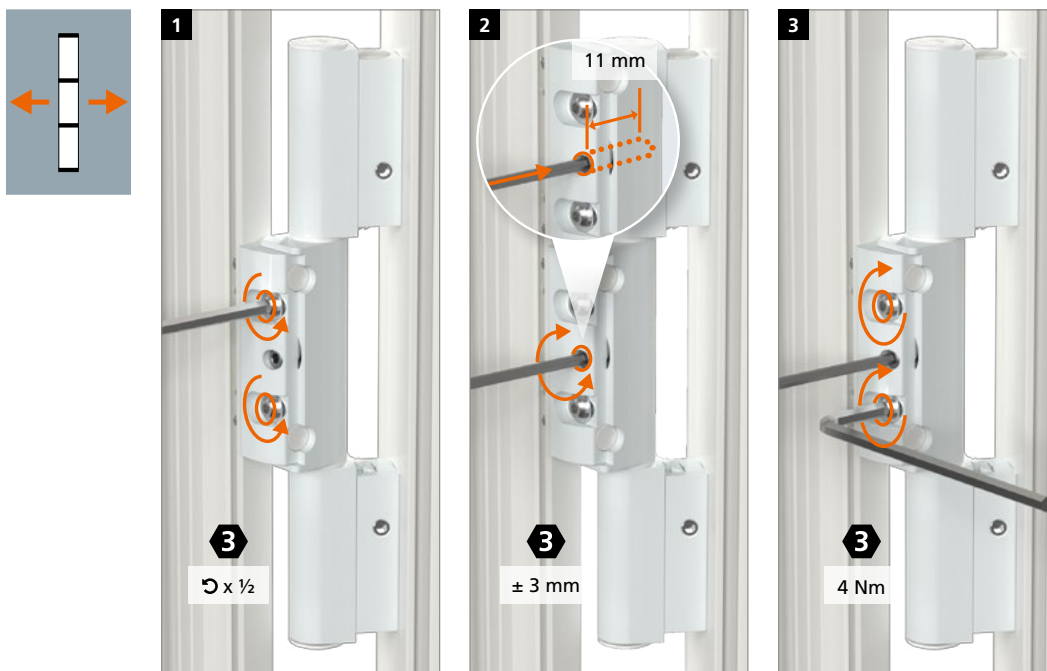

Dichtungsandruckverstellung · Réglage de la compression du joint d'étanchéité · Adjusting the sealing pressure

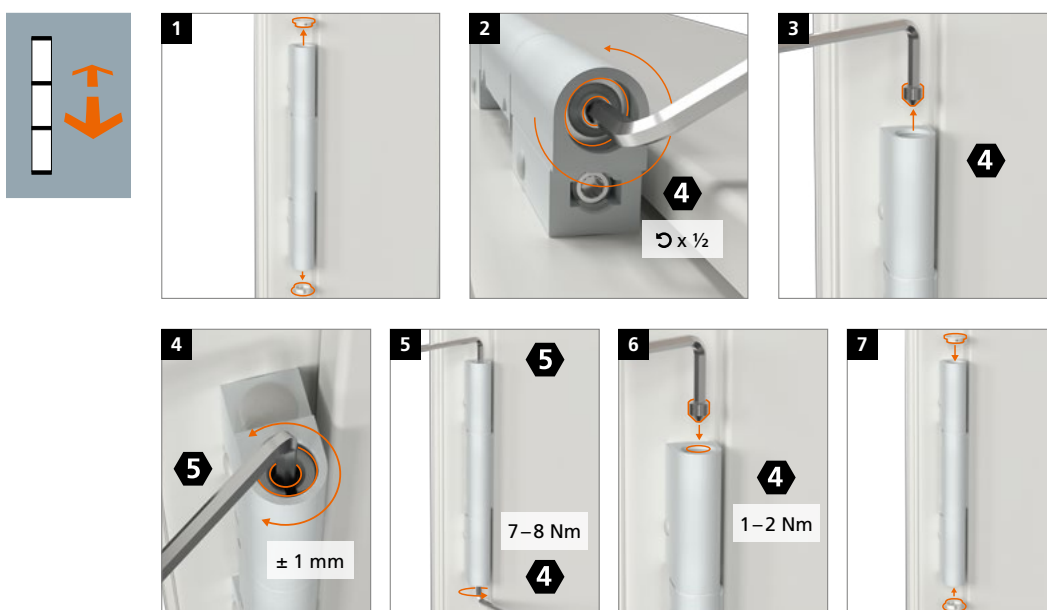



EINSTELLANLEITUNG

Notice de réglage
Adjustment instructions



Demontage an der Baustelle · Démontage sur le chantier · Disassembly on site

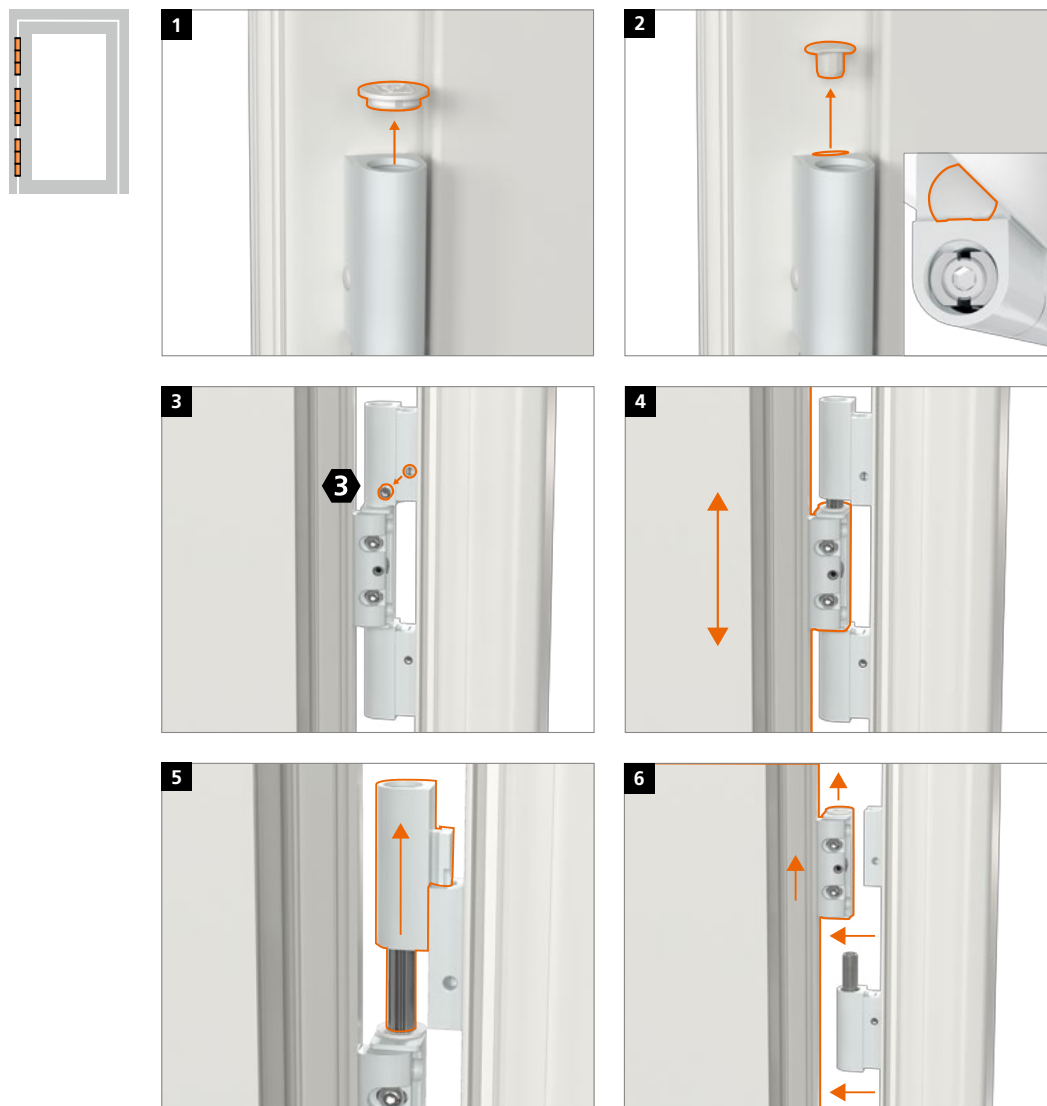



Hahn Serie 60 AT



Hahn KT-EV



Hahn VL-Band ST



Hahn Rollenband G



Hahn KT-RV



*Für jede
Situation
die passende
Lösung*



Hahn KT-V 6R



Hahn VL-Band 180



Hahn Rollenband NG



Hahn KT-RN



Hahn Türband 4 AT



Hahn KT-Rollenband NL



Hahn KT-SV



Hahn KT-B 6R



Hahn Türband 4 AT



Hahn KT-N 6R



Hahn Türband 4 HM0



Hahn KT-RKN



Hahn KT-RV



Hahn KT-EN



Hahn Rollenband AT



Hahn Serie 60 AT



Hahn VL-Band AT



Hahn Klemmband



Hahn KT-RKV



Hahn Klemmband



Hahn AT-G



Hahn KT-RN

 **Dr. Hahn**[®]
TÜRBÄNDER. MADE IN GERMANY.



Dr. Hahn GmbH & Co. KG

Trompeterallee 162-170 · D-41189 Mönchengladbach
Postfach 400109 · D-41181 Mönchengladbach
Phone +49(0)2166 954-3 · E-Mail: sales@dr-hahn.com
www.dr-hahn.eu