



Hahn KT-R



Butt hinge for entrance doors



Hahn "KT-R" – the favourite butt hinge for PVC doors now also available as a 3-part hinge.

The Hahn **KT-R** hinge may be used for almost all major PVC-U sections. It's a butt hinge for PVC-U doors which can be adjusted in six directions.

Even when the door is mounted, it is possible to adjust the hinge from a defined zero position

- horizontally by ± 3 mm and
- vertically by $+ 3$ mm and $- 1$ mm
- Adjustment of the sealing pressure $+ 0.5$ mm

To satisfy the high demand for a sophisticated appearance, particular attention was placed on ensuring that there is no misalignment of the hinge following significant adjustment. As a result, the hinge design always maintains its optimum contour. A throughout fastening bearing bolt assures additional stability

Pre-assembled and maintenance-free

Constructed using extruded aluminium, it is able to bear doors mounted on two hinges and weighing 140 kg depending on the construction of the door. At the same time, it may even be used for left and right-hand doors which open either inward or outward.

The hinge allows doors to open up to 180° .

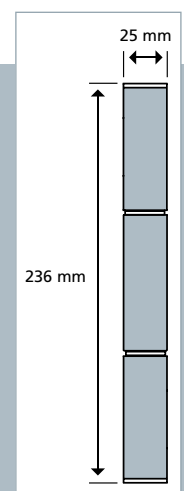
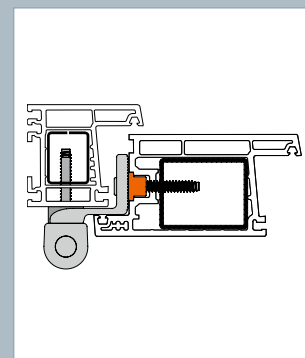



Hahn KT-R



Door hinges are delivered for the most part in a pre-assembled state. As is true for all Hahn hinges, the KT-R is absolutely maintenance-free and comes in all major RAL colours as well as anodised. Appropriate drilling jigs are available to facilitate a quick and simple installation.

Follows the current trend

The trend on the door construction market is moving towards butt hinges. With the new KT-R butt hinge Dr Hahn expands their production range with the much sought after 3-parts version.











AREAS OF APPLICATION

Doors made of plastic sections, suited for both residential and commercial structures:

- Main entrance doors
- Interior doors
- Entrance doors for flats
- Side entrance doors
- Exterior doors

SYSTEM/APPLICATION

- **Material:** Made of extruded aluminium
- **Fastening methods:** Direct screw connection in frame and door, optionally available with Hahn step screw
- **Load capacity:** Depending of profile section design max. 140 kg
- **Adjustability:** Without raising or removing the door adjustable in 5 directions:
 - Horizontal adjustment ± 3 mm
 - Vertical adjustment variable $+ 3$ mm, $- 1$ mm
 - Adjusting sealing pressure $\pm 0,5$ mm
- **Colors:** Hinges in RAL-Colors deliverable
- **Certifications:** CE-certified, Hinge class 11

								
	Service classes	Durability	Weight of test door	Fire resistance	Security	Corrosion resistance	Intrusion protection	Hinge class
	3	7	4	0	1	4	0	11

For an explanation of the tables, please look at our website www.dr-hahn.de