

**Einstellanleitung**  
**Notice de réglage**  
**Adjustment instructions**

Verstellung der Bänder nur durch im  
 Türenbau erfahrene Fachhandwerker.

Réglage et montage des paumelles  
 uniquement par des professionnels qualifiés.

Adjustment and regulation only to be  
 done by an experienced tradesman.



**Höhenverstellung · Réglage en hauteur · Adjusting the height**

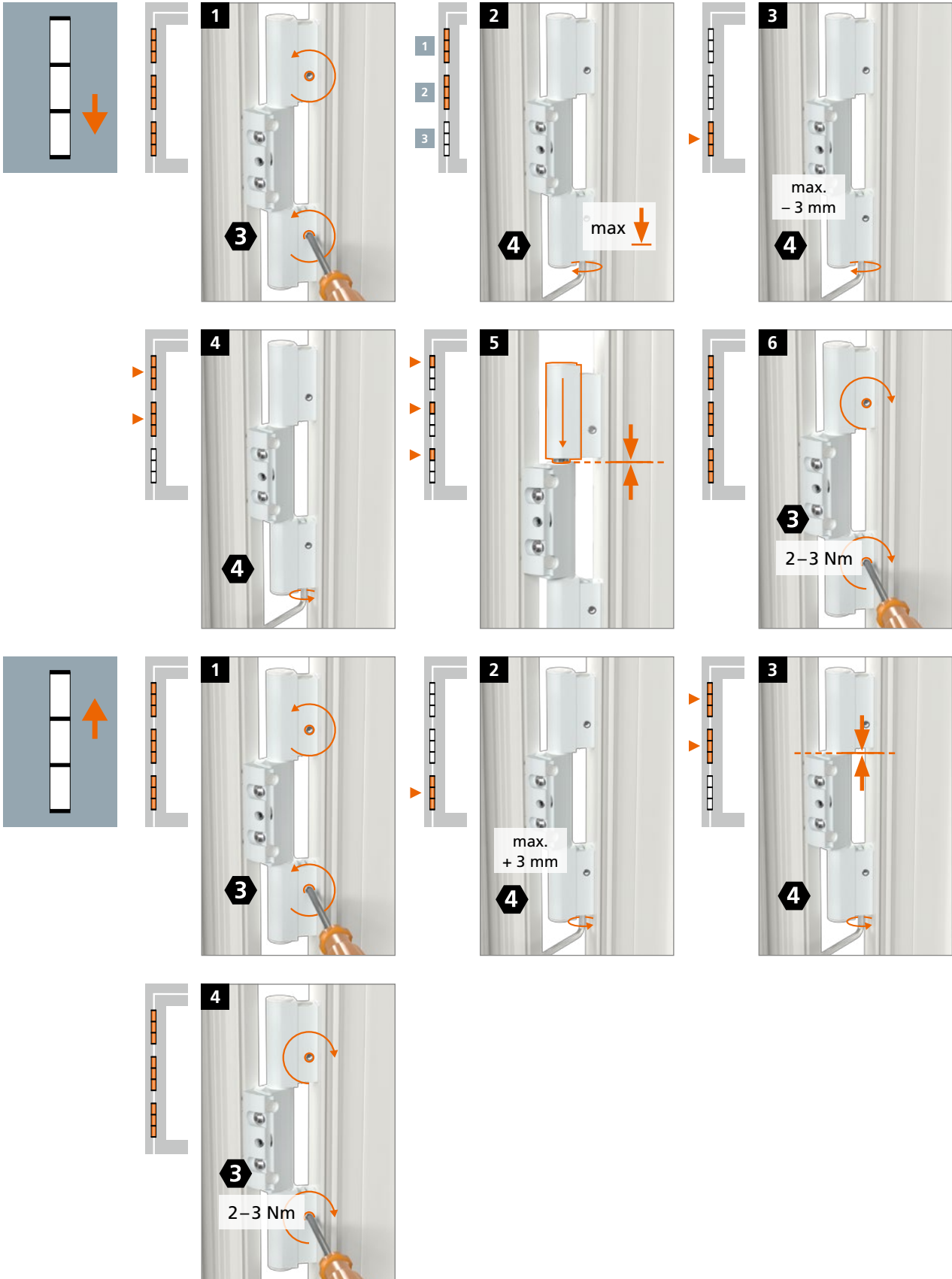

**Einstellanleitung**  
**Notice de réglage**  
**Adjustment instructions**

Verstellung der Bänder nur durch im  
 Türenbau erfahrene Fachhandwerker.

Réglage et montage des paumelles  
 uniquement par des professionnels qualifiés.

Adjustment and regulation only to be  
 done by an experienced tradesman.



**Horizontalverstellung · Réglage horizontal · Horizontal adjustment**

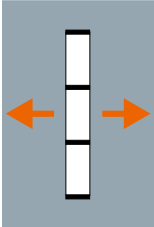

**Dichtungsdruckverstellung · Réglage de la compression du joint d'étanchéité · Adjusting the sealing pressure**

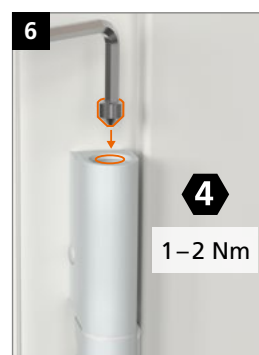
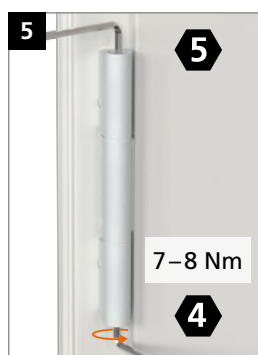
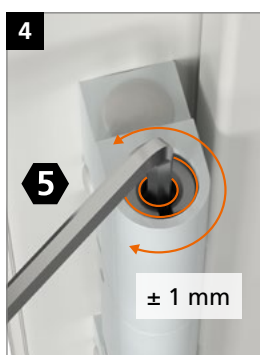
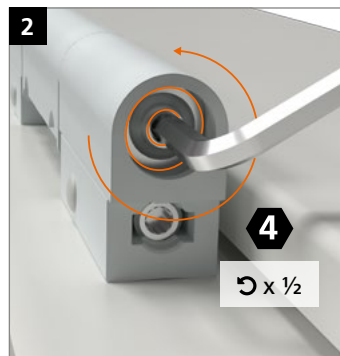
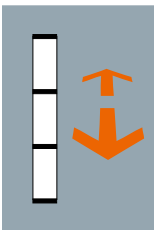

**Einstellanleitung**  
**Notice de réglage**  
**Adjustment instructions**

Verstellung der Bänder nur durch im  
 Türenbau erfahrene Fachhandwerker.

Réglage et montage des paumelles  
 uniquement par des professionnels qualifiés.

Adjustment and regulation only to be  
 done by an experienced tradesman.



**Demontage an der Baustelle · Démontage sur le chantier · Disassembly on site**

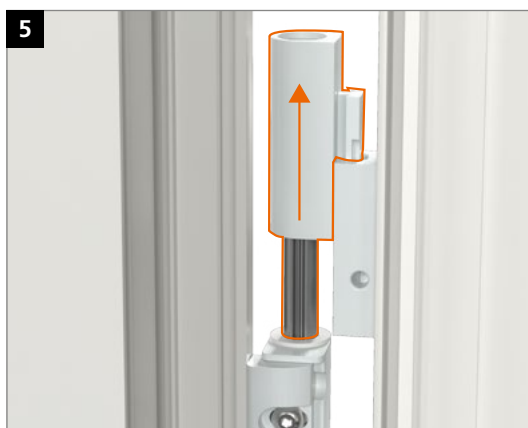
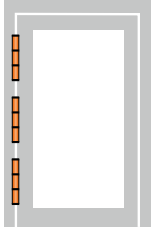

EBA KT-RKN 3-teilig D/F/GB/D-EBA0204/1.23/Technische Änderungen vorbehalten. Sous réserve de modifications techniques. Right to alter technical details reserved.

