

Einstellanleitung
Notice de réglage
Adjustment instructions

Verstellung der Bänder nur durch im
Türenbau erfahrene Fachhandwerker.

Réglage et montage des paumelles
uniquement par des professionnels qualifiés.

Adjustment and regulation only to be
done by an experienced tradesman.



Dichtungsdruckverstellung · Réglage de la compression du joint d'étanchéité · Adjusting the sealing pressure

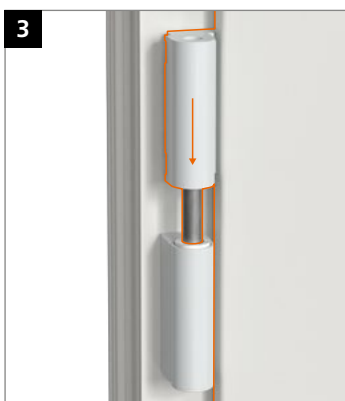
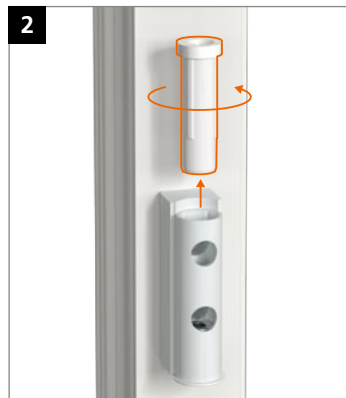
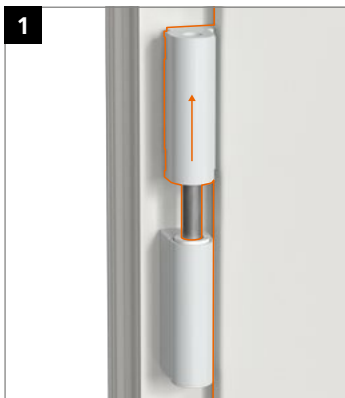
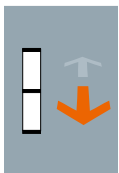
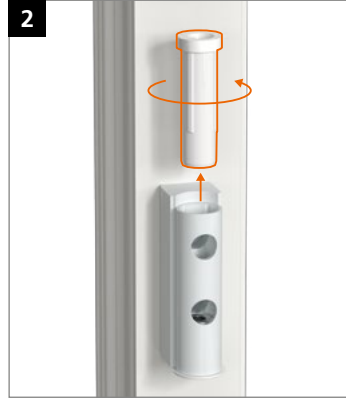
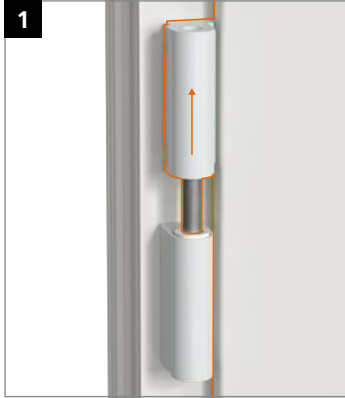
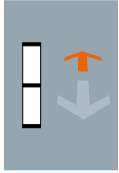

Einstellanleitung
Notice de réglage
Adjustment instructions

Verstellung der Bänder nur durch im
 Türenbau erfahrene Fachhandwerker.

Réglage et montage des paumelles
 uniquement par des professionnels qualifiés.

Adjustment and regulation only to be
 done by an experienced tradesman.



Höhenverstellung · Réglage en hauteur · Adjusting the height

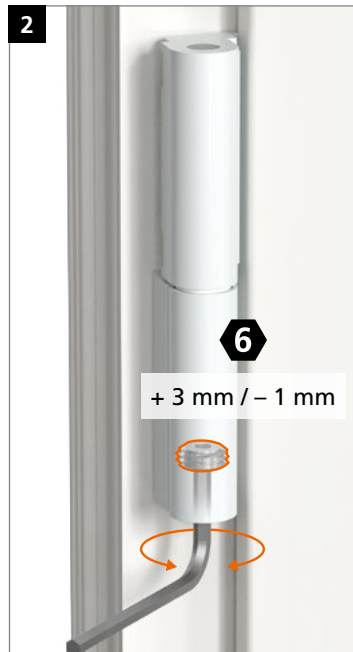
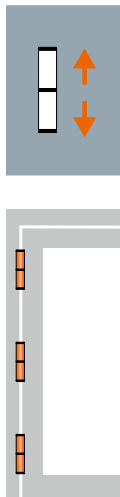

Horizontalverstellung · Réglage horizontal · Horizontal adjustment

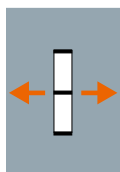

EBA KT-RV 2-teilig D/F/GB/D-EBA0233/10.23/Technische Änderungen vorbehalten. Sous réserve de modifications techniques. Right to alter technical details reserved.

