

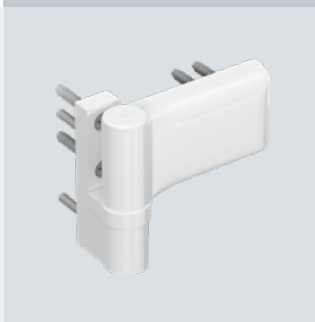

Hahn Produktkatalog

F Catalogue produits

GB Product catalogue

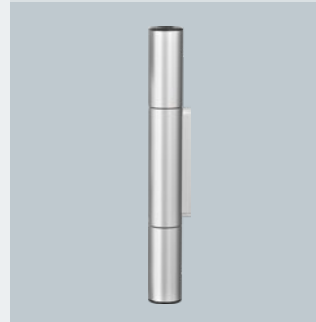
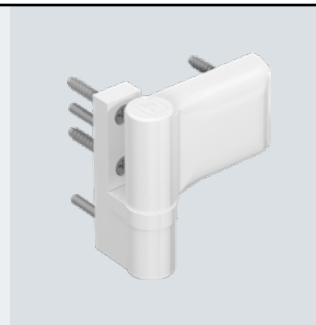



HAHN KT-RKN



DESCRIPTION

During the development of new versions of butt hinges for PVC doors, great importance was attached to ensuring that the look of the hinge curl remains delicate and that the hinges bear the weight of doors commonly used with PVC profile sections. Depending on the design of the profile sections, 2-piece hinges are able to support doors weighing up to 90 kg. In addition, door makers also have the option of pre-drilling into the prechamber alone – in other words only in the plastic – and supporting door leaves weighing up to max. 80 kg by using shorter pins and self-drilling screws.

Mounting and removing the door leaf is particularly easy and convenient. One hinge part can be easily mounted and removed in any position without having to loosen the fastening screws.

The seal always remains intact when it comes to the Hahn KT-RKN. Thus, the door retains its maximum characteristics for keeping out heat, wind and moisture.

- Areas of application:
Doors made of PVC sections, suited for both residential and commercial structures
 - Main entrance doors
 - Side entrance doors
 - Entrance doors for flats
 - Functional doors, e. g., emergency exit doors
- No lateral misalignment
- Door hinges are largely pre-assembled



SYSTEM/APPLICATION

- Material: Constructed of extruded aluminium
- Fastening method: Directly mounted in frame and upstand
- Versions: Upstand ranges from 16.5 mm
- Load capacity: Depending on profile section design
 - 2-piece with long pins supports max. 90 kg
 - 2-piece with short pins supports max. 80 kg
- Adjustability: Door leaf adjustable in six directions
 - Horizontal adjustment variable ± 3 mm
 - Height adjustment, variable up to ± 3 mm
 - Adjustment of sealing pressure variable ± 1 mm
- Certifications: CE certified according to EN1935:2002, hinge class 13
- Colours:
Hinges available in EV1 and RAL colours
- Allows door to open up 180°
- Usable DIN left/DIN right
- Bearing point is maintenance-free



KLEINES ROLLENBAND FÜR KUNSTSTOFFTÜREN

Paumelle cylindrique harmonieuse pour porte PVC
Small „Rollenband“ for PVC doors



Bestell-Schlüssel/Art.-Nr. · Codes clés/No. d'article · Order key/item number

- 1** = EV1 schwarze Kunststoffteile / Pièces PVC noires / Black PVC parts
- G** = RAL 9016 weiße Kunststoffteile / Pièces PVC blanches / White PVC parts
- 9** = Sonderfarbe schwarze Kunststoffteile / Teinte spéciale pièces PVC noires / Custom colours black PVC parts

Bei Schlüsselziffer 9 bitte Sonderfarbe benennen. Beispiel: RAL 9005 Tiefschwarz.
 Pour le code teinte 9, veuillez indiquer la teinte spéciale. Exemple : RAL 9005 noir foncé.
 If you select No. 9, please indicate custom colour. Example: RAL 9005 jet black.

Verpackungseinheit: 1 Band im Karton / Unité d'emballage : 1 paumelle par boîte / Packaging unit: 1 hinge per box

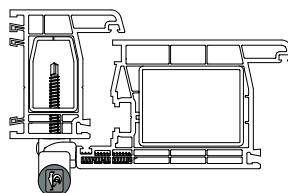

Flügelanbindung 0° / Adapter mit langen Stiften
 Chant d'ouvrant 0° /
 Embase dormant avec tenons de centrage longs
 Door connection 0° / Adapter with long pins

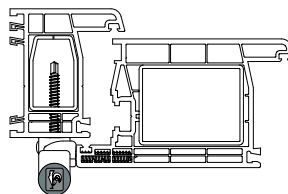

  K811 0001
  K811 0101

Flügelanbindung 0° / Adapter mit kurzen Stiften
 Chant d'ouvrant 0° /
 Embase dormant avec tenons de centrage courts
 Door connection 0° / Adapter with short pins



  K811 0002

Flügelanbindung 5° / Adapter mit langen Stiften
 Chant d'ouvrant 5° /
 Embase dormant avec tenons de centrage longs
 Door connection 5° / Adapter with long pins

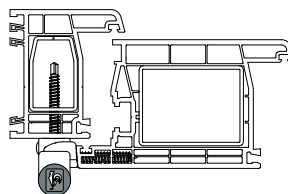



  K812 0001
  K812 0101

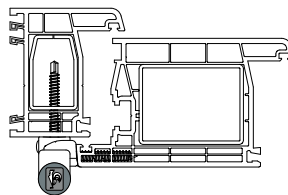

Adapter mit langen Stiften
 Embase dormant avec tenons
 de centrage longs
 Adapter with long pins

Flügelanbindung 5° / Adapter mit kurzen Stiften
 Chant d'ouvrant 5° /
 Embase dormant avec tenons de centrage courts
 Door connection 5° / Adapter with short pins



  K812 0002



Adapter mit kurzen Stiften
 Embase dormant avec tenons
 de centrage courts
 Adapter with short pins



Selbstbohrende
 Schrauben
 Vis autoperforantes
 Self-tapping screws



Direktverschraubung
 Vissage direct
 Direct screw connection

Technische Änderungen vorbehalten. Andere Farben auf Anfrage.
 Sous réserve de modifications techniques. Autres teintes sur demande.
 Right to alter technical details reserved. Other colours available on request.



KLEINES ROLLENBAND FÜR KUNSTSTOFFTÜREN

Paumelle cylindrique harmonieuse pour porte PVC
Small „Rollenband“ for PVC doors



Bestell-Schlüssel / Art.-Nr. · Codes clés / No. d'article · Order key / item number

- 1** = EV1 schwarze Kunststoffteile / Pièces PVC noires / Black PVC parts
- G** = RAL 9016 weiße Kunststoffteile / Pièces PVC blanches / White PVC parts
- 9** = Sonderfarbe schwarze Kunststoffteile / Teinte spéciale pièces PVC noires / Custom colours black PVC parts

Bei Schlüsselziffer 9 bitte Sonderfarbe benennen. Beispiel: RAL 9005 Tiefschwarz.
Pour le code teinte 9, veuillez indiquer la teinte spéciale. Exemple : RAL 9005 noir foncé.
If you select No. 9, please indicate custom colour. Example: RAL 9005 jet black.

Verpackungseinheit: 24 Bänder im Karton / Unité d'emballage : 24 paumelles par boîte / Packaging unit: 24 hinges per box

Flügelanbindung 0° / Adapter mit langen Stiften
Chant d'ouvrant 0° /
Embase dormant avec tenons de centrage longs
Door connection 0° / Adapter with long pins

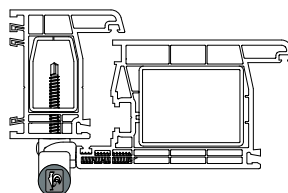

K811 V001
 K811 V101

Flügelanbindung 0° / Adapter mit kurzen Stiften
Chant d'ouvrant 0° /
Embase dormant avec tenons de centrage courts
Door connection 0° / Adapter with short pins

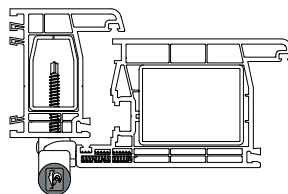

K811 V002

Flügelanbindung 5° / Adapter mit langen Stiften
Chant d'ouvrant 5° /
Embase dormant avec tenons de centrage longs
Door connection 5° / Adapter with long pins

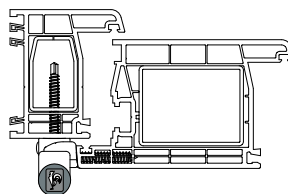

K812 V001
 K812 V101

Flügelanbindung 5° / Adapter mit kurzen Stiften
Chant d'ouvrant 5° /
Embase dormant avec tenons de centrage courts
Door connection 5° / Adapter with short pins

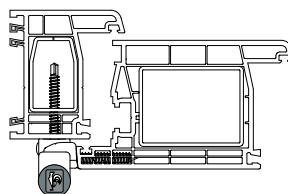

K812 V002

Zubehör / Artikel-Nr. · Accessoires / No. d'article · Accessories / Item number

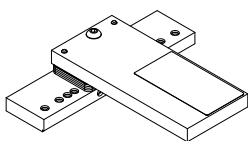

Bohrlehre
Gabarit de perçage
Drilling jig
No. T317A0000



KT-Senkkopfschraube 6,3x80 für Rahmen/
Vis à tête fraisée 6,3x80 pour dormant/
Countersunk screw 6,3x80 for frame
No. K500E0007

Technische Änderungen vorbehalten. Andere Farben auf Anfrage.
Sous réserve de modifications techniques. Autres teintes sur demande.
Right to alter technical details reserved. Other colours available on request.



EINSTELLANLEITUNG

Notice de réglage
Adjustment instructions



Höhenverstellung · Réglage en hauteur · Adjusting the height

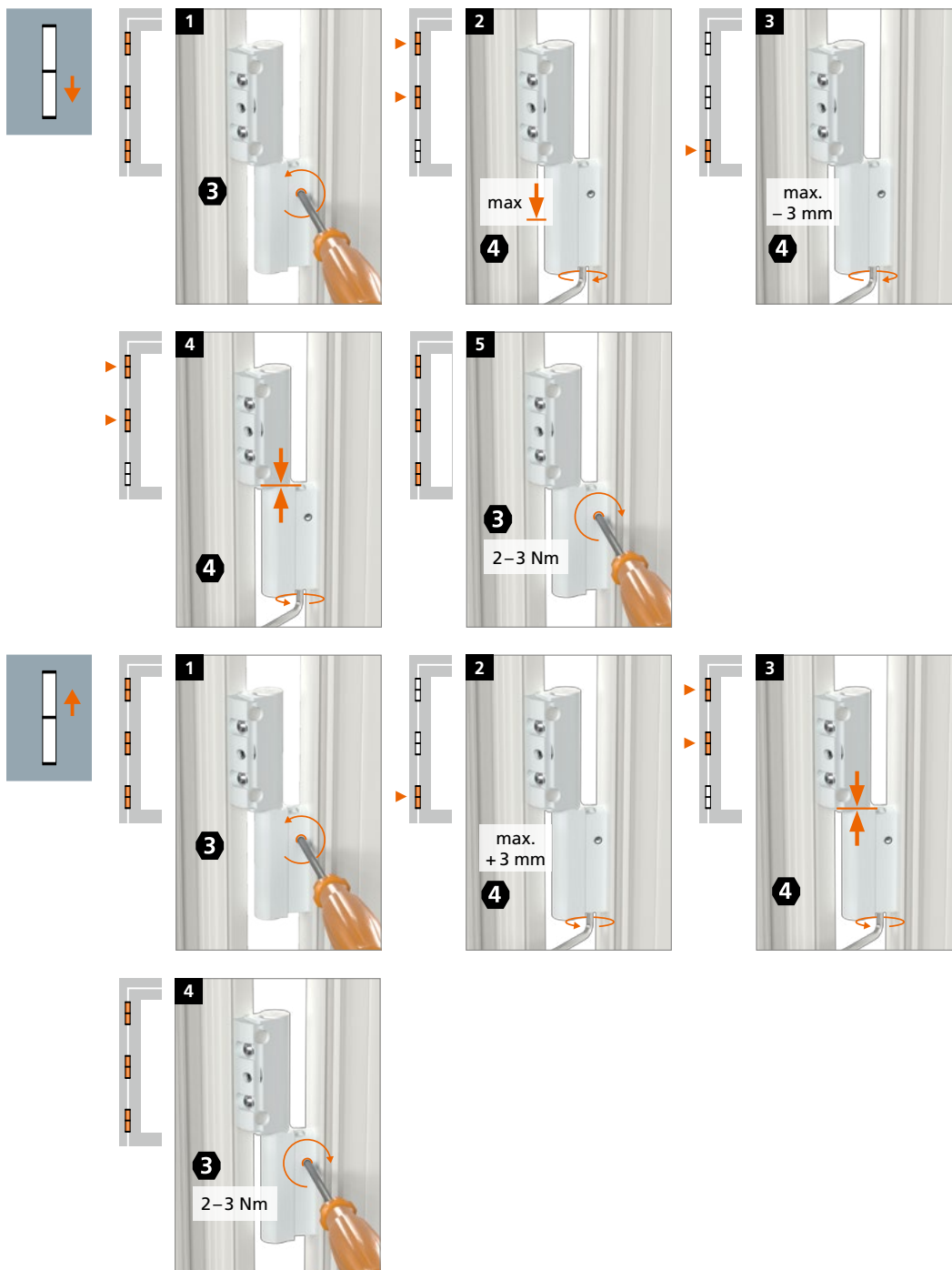



EINSTELLANLEITUNG

Notice de réglage
Adjustment instructions



Horizontalverstellung · Réglage horizontal · Horizontal adjustment

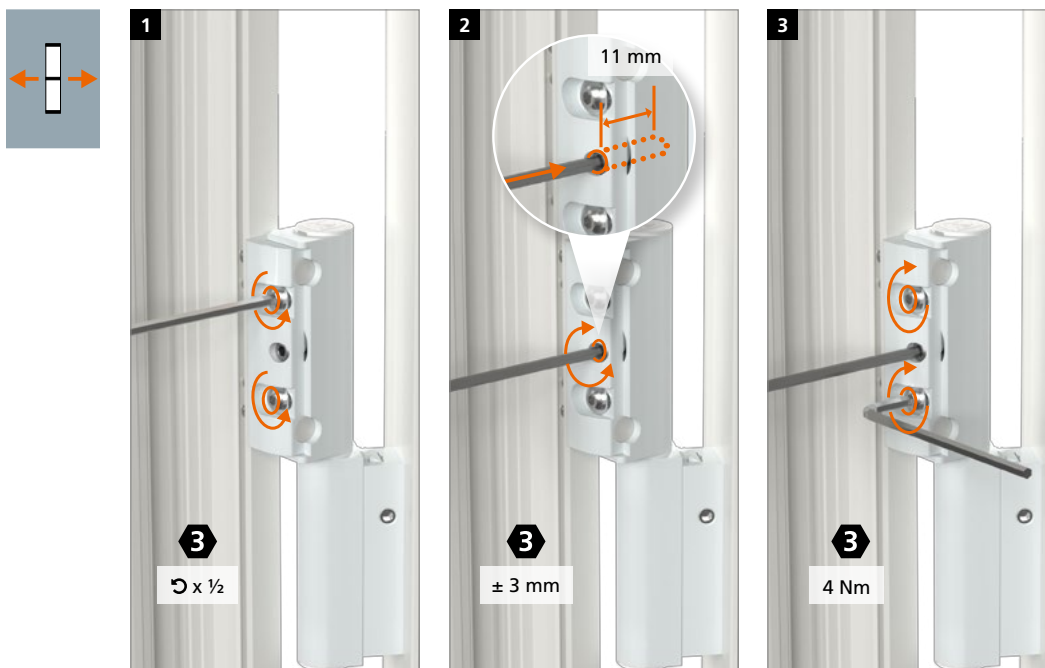

Dichtungsdruckverstellung · Réglage de la compression du joint d'étanchéité · Adjusting the sealing pressure

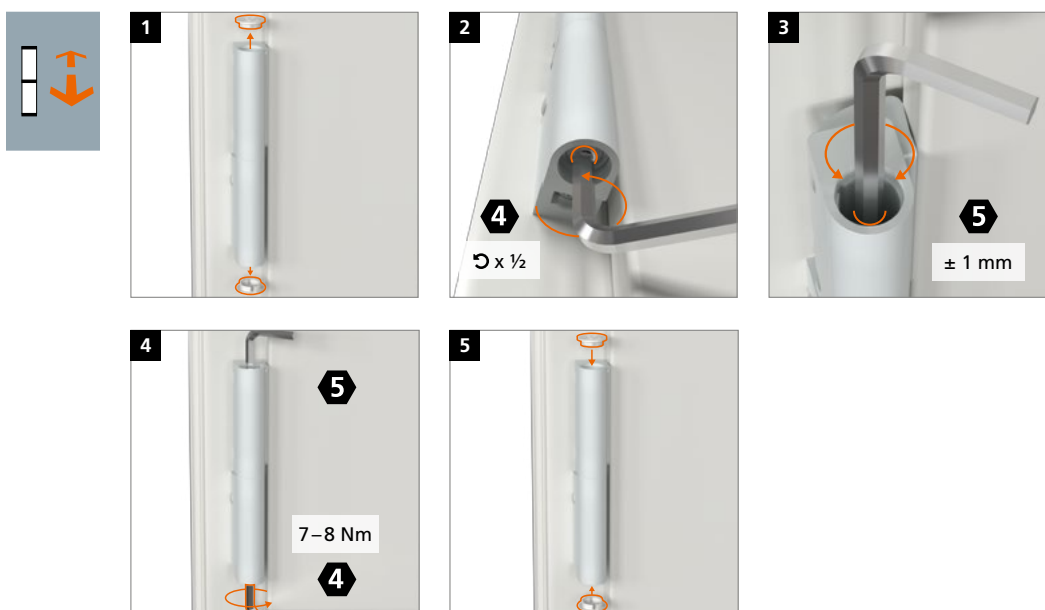



Hahn Serie 60 AT



Hahn KT-EV



Hahn VL-Band ST



Hahn Rollenband G



Hahn KT-RV



*Für jede
Situation
die passende
Lösung*



Hahn KT-V 6R



Hahn VL-Band 180



Hahn Rollenband NG



Hahn KT-RN



Hahn Türband 4 AT



Hahn KT-Rollenband NL



Hahn KT-SV



Hahn KT-B 6R



Hahn Türband 4 AT



Hahn KT-N 6R



Hahn Türband 4 HM0



Hahn KT-RKN



Hahn KT-RV



Hahn KT-EN



Hahn Rollenband AT



Hahn Serie 60 AT



Hahn VL-Band AT



Hahn Klemmband



Hahn KT-RKV



Hahn Klemmband



Hahn AT-G



Hahn KT-RN

 **Dr. Hahn**[®]
TÜRBÄNDER. MADE IN GERMANY.



Dr. Hahn GmbH & Co. KG

Trompeterallee 162-170 · D-41189 Mönchengladbach
Postfach 400109 · D-41181 Mönchengladbach
Phone +49(0)2166 954-3 · E-Mail: sales@dr-hahn.com
www.dr-hahn.eu