



Hahn Produktkatalog

F Catalogue produits

GB Product catalogue





HAHN KT-RKN



DESCRIPTION

The 3-piece Hahn KT-RKN is able to support doors weighing up to 120 kg, depending on the design of the profile sections. With its 18 mm hinge curl, the hinge appears to be incredibly slender. It is suitable for all major profile systems. To attain the greatest possible positive fit, the KT-RKN with the door hinge parts is available for a right-angled connection (0°) and for a slightly slanted connection (5°). The result is a versatile kit that allows door makers to select the butt hinge that is suitable of their requirements. It can also be used for upstand situations of 16.5 mm to 26 mm. A universally usable drilling jig makes work easier for door makers in the workshop.

Mounting and removing the door leaf is particularly easy and convenient. One hinge part can be easily mounted and removed in any position without having to loosen the fastening screws.

The seal always remains intact when it comes to the Hahn KT-RKN. Thus, the door retains its maximum characteristics for keeping out heat, wind and moisture.

- Areas of application:
 - Doors made of PVC sections, suited for both residential and commercial structures
 - Main entrance doors
 - Side entrance doors
 - Entrance doors for flats
 - Functional doors, e. g., emergency exit doors
- No lateral misalignment
- Door hinges are largely pre-assembled



SYSTEM / APPLICATION

- Material: Constructed of extruded aluminium
- Fastening method: Directly mounted in frame and upstand
- Versions: Upstand ranges from 16.5 mm
- Load capacity:
 - Depending on profile section design max. 120 kg
- Adjustability: Door leaf adjustable in six directions
 - Horizontal adjustment variable ± 3 mm
 - Height adjustment, variable up to ± 3 mm
 - Adjustment of sealing pressure variable ± 1 mm
- Certifications: CE certified according to EN1935:2002, hinge class 13
- Colours:
 - Hinges available in EV1 and RAL colours
- Allows door to open up 180°
- Usable DIN left / DIN right
- Bearing point is maintenance-free



KLEINES ROLLENBAND FÜR KUNSTSTOFFTÜREN

Paumelle cylindrique harmonieuse pour porte PVC
Small „Rollenband“ for PVC doors



Bestell-Schlüssel/Art.-Nr. · Codes clés/No. d'article · Order key/item number

- 1** = EV1 schwarze Kunststoffteile / Pièces PVC noires / Black PVC parts
- G** = RAL 9016 weiße Kunststoffteile / Pièces PVC blanches / White PVC parts
- 9** = Sonderfarbe schwarze Kunststoffteile / Teinte spéciale pièces PVC noires / Custom colours black PVC parts

Bei Schlüsselziffer 9 bitte Sonderfarbe benennen. Beispiel: RAL 9005 Tiefschwarz.
Pour le code teinte 9, veuillez indiquer la teinte spéciale. Exemple : RAL 9005 noir foncé.
If you select No. 9, please indicate custom colour. Example: RAL 9005 jet black.

Verpackungseinheit: 1 Band im Karton / Unité d'emballage : 1 paumelle par boîte / Packaging unit: 1 hinge per box

Flügelanbindung 0° / Adapter mit langen Stiften
Chant d'ouvrant 0° /
Embase dormant avec tenons de centrage longs
Door connection 0° / Adapter with long pins

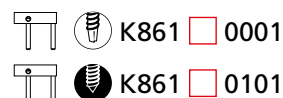
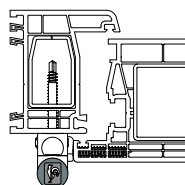

Flügelanbindung 5° / Adapter mit langen Stiften
Chant d'ouvrant 5° /
Embase dormant avec tenons de centrage longs
Door connection 5° / Adapter with long pins

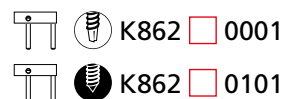
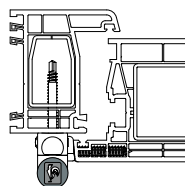

Verpackungseinheit: 24 Bänder im Karton / Unité d'emballage : 24 paumelles par boîte / Packaging unit: 24 hinges per box

Flügelanbindung 0° / Adapter mit langen Stiften
Chant d'ouvrant 0° /
Embase dormant avec tenons de centrage longs
Door connection 0° / Adapter with long pins

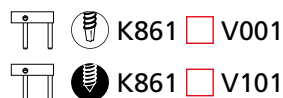
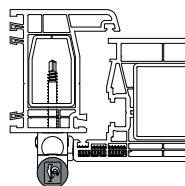

Flügelanbindung 5° / Adapter mit langen Stiften
Chant d'ouvrant 5° /
Embase dormant avec tenons de centrage longs
Door connection 5° / Adapter with long pins

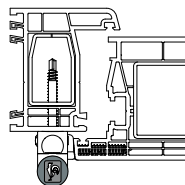

Adapter mit langen Stiften
Embase dormant avec tenons de centrage longs
Adapter with long pins



Selbstbohrende
Schrauben
Vis autoperforantes
Self-tapping screws



Direktverschraubung
Vissage direct
Direct screw connection

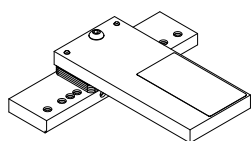

Bohrlehre
Gabarit de perçage
Drilling jig
No. T317A0000



KT-Senkkopfschraube 6,3x80 für Rahmen/
Vis à tête fraisée 6,3x80 pour dormant/
Countersunk screw 6,3x80 for frame
No. K500E0007

Technische Änderungen vorbehalten. Andere Farben auf Anfrage.
Sous réserve de modifications techniques. Autres teintes sur demande.
Right to alter technical details reserved. Other colours available on request.

Zubehör/Artikel-Nr. · Accessoires/No. d'article · Accessories/Item number



EINSTELLANLEITUNG

Notice de réglage
Adjustment instructions



Höhenverstellung · Réglage en hauteur · Adjusting the height

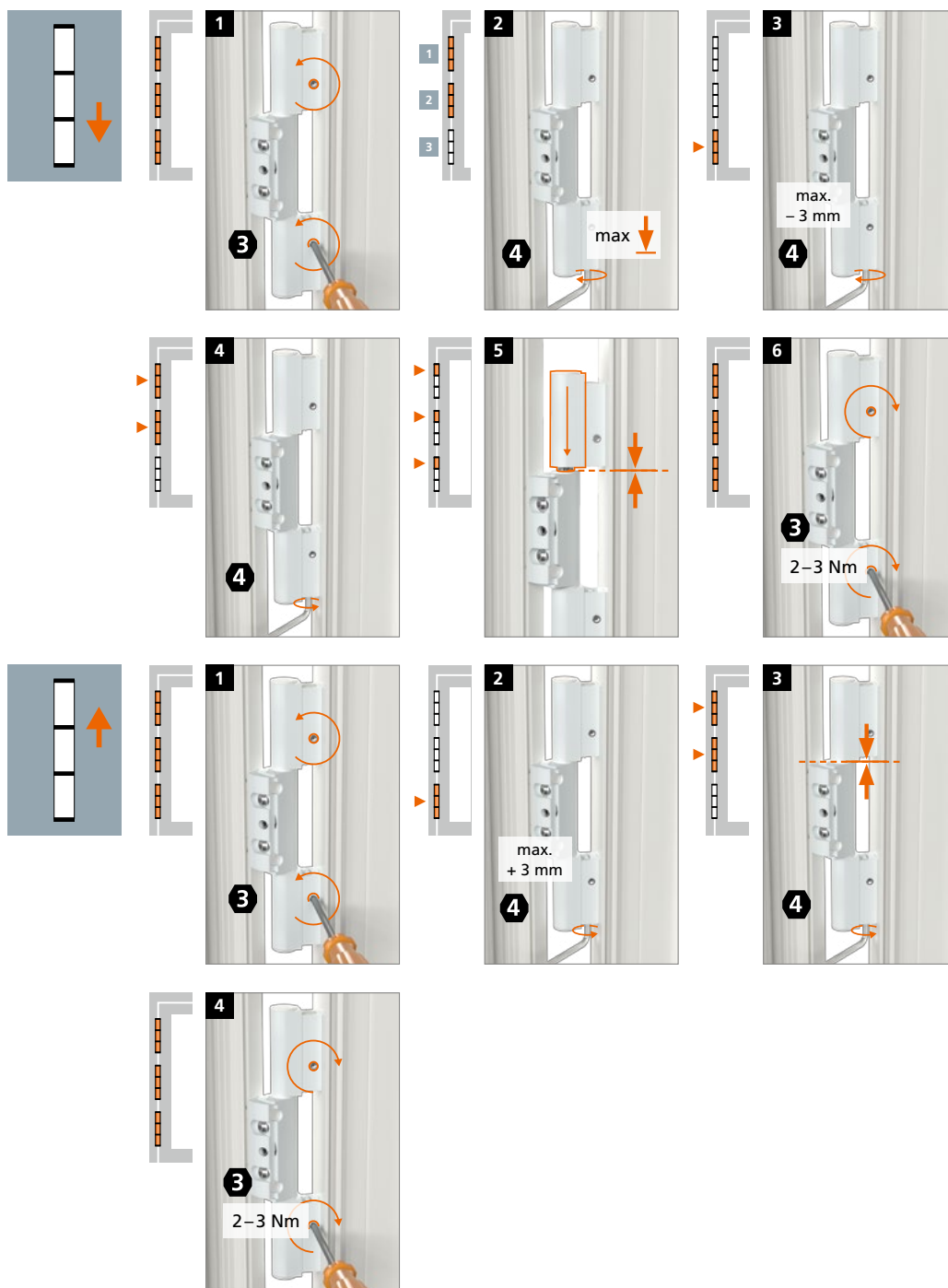



EINSTELLANLEITUNG

Notice de réglage
Adjustment instructions



Horizontalverstellung · Réglage horizontal · Horizontal adjustment

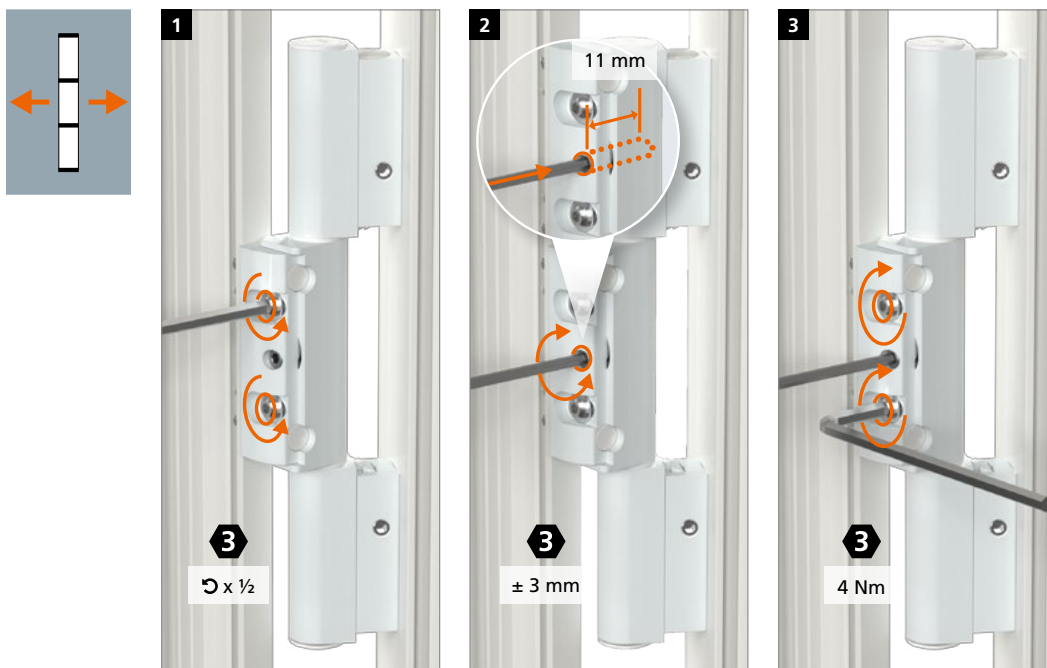

Dichtungsandruckverstellung · Réglage de la compression du joint d'étanchéité · Adjusting the sealing pressure

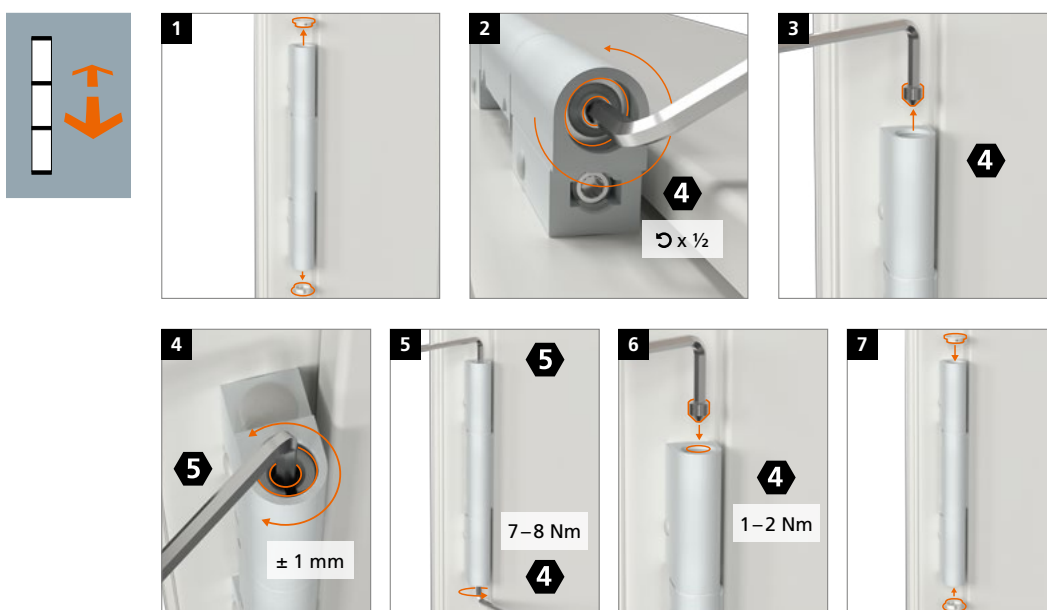



EINSTELLANLEITUNG

Notice de réglage
Adjustment instructions



Demontage an der Baustelle · Démontage sur le chantier · Disassembly on site

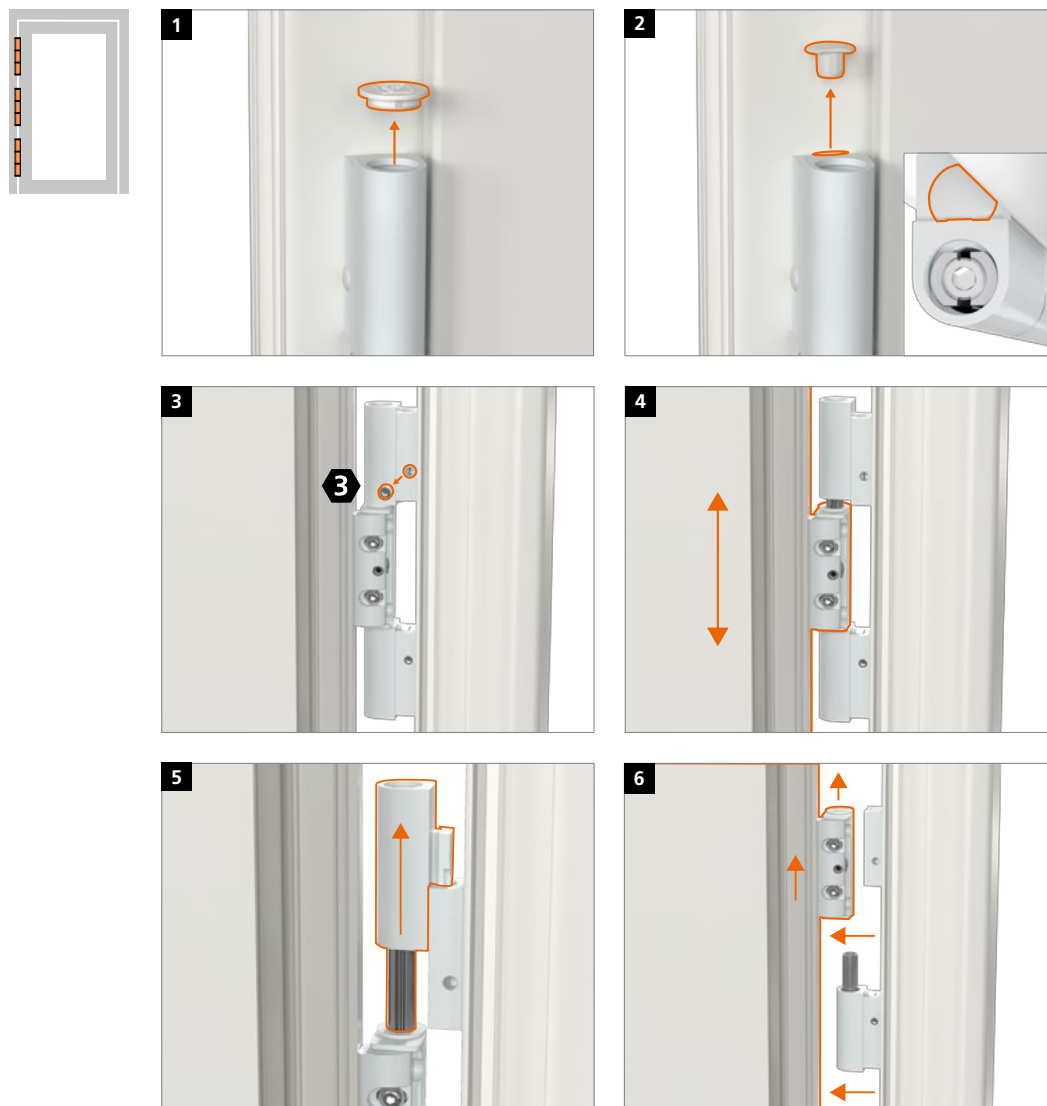



Hahn Serie 60 AT



Hahn KT-EV



Hahn VL-Band ST



Hahn Rollenband G



Hahn KT-RV



*Für jede
Situation
die passende
Lösung*



Hahn KT-V 6R



Hahn VL-Band 180



Hahn Rollenband NG



Hahn KT-RN



Hahn Türband 4 AT



Hahn KT-Rollenband NL



Hahn KT-SV



Hahn KT-B 6R



Hahn Türband 4 AT



Hahn KT-N 6R



Hahn Türband 4 HM0



Hahn KT-RKN



Hahn KT-RV



Hahn KT-EN



Hahn Rollenband AT



Hahn Serie 60 AT



Hahn VL-Band AT



Hahn Klemmband



Hahn KT-RKV



Hahn Klemmband



Hahn AT-G



Hahn KT-RN

 **Dr. Hahn**[®]
TÜRBÄNDER. MADE IN GERMANY.



Dr. Hahn GmbH & Co. KG

Trompeterallee 162 – 170 · D-41189 Mönchengladbach
Postfach 400109 · D-41181 Mönchengladbach
Phone +49(0)2166 954-3 · E-Mail: sales@dr-hahn.com
www.dr-hahn.eu