



Hahn Produktkatalog

F Catalogue produits

GB Product catalogue





HAHN KT-RKV



DESCRIPTION

The Hahn KT-RKV is fastened with screws in the rebate as is common for butt hinges. Depending on the design of the profile sections, 2-piece hinges are able to support doors weighing up to 90 kg. The 2-piece hinges are fastened with the aid of self-drilling screws in the reinforcement of the frame profile with long pins to distribute the forces, acting on the hinge. In addition, door makers also have the option of pre-drilling into the prechamber alone – in other words only in the plastic – and supporting door leaves weighing up to max. 80 kg by using shorter pins and self-drilling screws.

Processing in workshops and at the building site is particularly effective. Mounting and removal of the door leaf is easy and convenient. One hinge part can be easily mounted and removed in any position without having to loosen the fastening screws. A huge advantage for a low door lintel and a key factor in making work easier for installation personnel on the building site.

- Areas of application:
 - Doors made of PVC sections, suited for both residential and commercial structures
 - Main entrance doors
 - Side entrance doors
 - Entrance doors for flats
 - Functional doors, e. g., emergency exit doors
- No lateral misalignment
- Door hinges are largely pre-assembled



SYSTEM / APPLICATION

- Material: Constructed of extruded aluminium
- Fastening method: Directly mounted in frame and groove
- Euro-Groove versions 16 mm, 20 mm, 24 mm
- Load capacity: Depending on profile section design
 - 2-piece with long pins supports max. 90 kg
 - 2-piece with short pins supports max. 80 kg
- Adjustability: Door leaf adjustable in six directions
 - Horizontal adjustment variable ± 3 mm
 - Height adjustment, variable up to ± 3 mm
 - Adjustment of sealing pressure variable ± 1 mm
- Certifications: CE certified according to EN1935:2002, hinge class 13
- Colours:
 - Hinges available in EV1 and RAL colours
- Allows door to open up 180°
- Usable DIN left / DIN right
- Bearing point is maintenance-free



KLEINES ROLLENBAND FÜR KUNSTSTOFFTÜREN

Paumelle cylindrique harmonieuse pour porte PVC
Small „Rollenband“ for PVC doors



Bestell-Schlüssel / Art.-Nr. · Codes clés / No. d'article · Order key / item number

- 1** = EV1 schwarze Kunststoffteile / Pièces PVC noires / Black PVC parts
- G** = RAL 9016 weiße Kunststoffteile / Pièces PVC blanches / White PVC parts
- 9** = Sonderfarbe schwarze Kunststoffteile / Teinte spéciale pièces PVC noires / Custom colours black PVC parts

Bei Schlüsselziffer 9 bitte Sonderfarbe benennen. Beispiel: RAL 9005 Tiefschwarz.
Pour le code teinte 9, veuillez indiquer la teinte spéciale. Exemple : RAL 9005 noir foncé.
If you select No. 9, please indicate custom colour. Example: RAL 9005 jet black.

Verpackungseinheit: 1 Band im Karton / Unité d'emballage : 1 paumelle par boîte / Packaging unit: 1 hinge per box

16/3,0 mm und 16/3,5 mm Beschlagnut/
Adapter mit langen Stiften
16/3,0 mm et 16/3,5 mm feuillure/
Embase dormant avec tenons de centrage longs
16/3.0 mm and 16/3.5 mm hinge groove/
Adapter with long pins

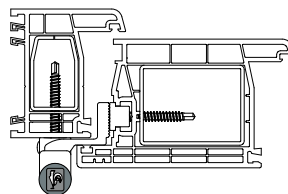

24/4,0 mm Beschlagnut/
Adapter mit langen Stiften
24/4,0 mm feuillure/
Embase dormant avec tenons de centrage longs
24/4.0 mm hinge groove/
Adapter with long pins

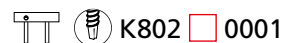
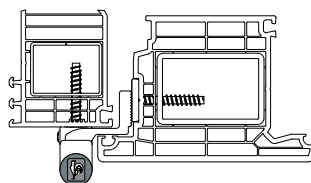

16/3,0 mm und 16/3,5 mm Beschlagnut/
Adapter mit kurzen Stiften
16/3,0 mm et 16/3,5 mm feuillure/
Embase dormant avec tenons de centrage courts
16/3.0 mm and 16/3.5 mm hinge groove/
Adapter with short pins

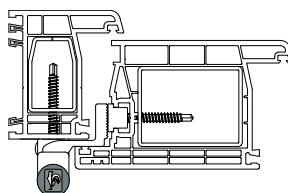

Adapter mit langen Stiften
Embase dormant avec tenons
de centrage longs
Adapter with long pins



Adapter mit kurzen Stiften
Embase dormant avec tenons
de centrage courts
Adapter with short pins



Selbstbohrende
Schrauben
Vis autoperforantes
Self-tapping screws



Direktverschraubung
Vissage direct
Direct screw connection

Technische Änderungen vorbehalten. Andere Farben auf Anfrage.
Sous réserve de modifications techniques. Autres teintes sur demande.
Right to alter technical details reserved. Other colours available on request.



KLEINES ROLLENBAND FÜR KUNSTSTOFFTÜREN

Paumelle cylindrique harmonieuse pour porte PVC
Small „Rollenband“ for PVC doors



Bestell-Schlüssel / Art.-Nr. · Codes clés / No. d'article · Order key / item number

- 1** = EV1 schwarze Kunststoffteile / Pièces PVC noires / Black PVC parts
- G** = RAL 9016 weiße Kunststoffteile / Pièces PVC blanches / White PVC parts
- 9** = Sonderfarbe schwarze Kunststoffteile / Teinte spéciale pièces PVC noires / Custom colours black PVC parts

Bei Schlüsselziffer 9 bitte Sonderfarbe benennen. Beispiel: RAL 9005 Tiefschwarz.
Pour le code teinte 9, veuillez indiquer la teinte spéciale. Exemple : RAL 9005 noir foncé.
If you select No. 9, please indicate custom colour. Example: RAL 9005 jet black.

Verpackungseinheit: 24 Bänder im Karton / Unité d'emballage : 24 paumelles par boîte / Packaging unit: 24 hinges per box

16/3,0 mm und 16/3,5 mm Beschlagnut/
Adapter mit langen Stiften
16/3,0 mm et 16/3,5 mm feuillure/
Embase dormant avec tenons de centrage longs
16/3.0 mm and 16/3.5 mm hinge groove/
Adapter with long pins

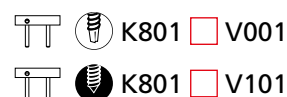
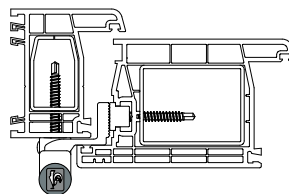

24/4,0 mm Beschlagnut/
Adapter mit langen Stiften
24/4,0 mm feuillure/
Embase dormant avec tenons de centrage longs
24/4.0 mm hinge groove/
Adapter with long pins

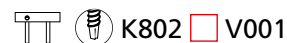
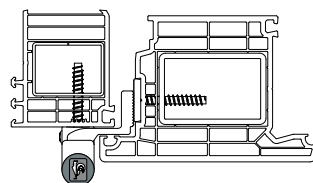

16/3,0 mm und 16/3,5 mm Beschlagnut/
Adapter mit kurzen Stiften
16/3,0 mm et 16/3,5 mm feuillure/
Embase dormant avec tenons de centrage courts
16/3.0 mm and 16/3.5 mm hinge groove/
Adapter with short pins

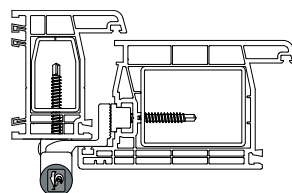

Zubehör / Artikel-Nr. · Accessoires / No. d'article · Accessories / Item number

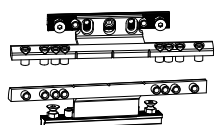

Bohrlehre
Gabarit de perçage
Drilling jig
No. T318A0000

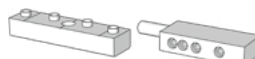

Bohrlehre für 24/4,0 mm Beschlagnut
Gabarit de perçage pour feuillure 24/4,0 mm
Drilling jig for 24/4.0 mm hinge groove
No. T318A0001



KT-Senkkopfschraube 6,3x80 für Rahmen
Vis à tête fraisée 6,3x80 pour dormant/
Countersunk screw 6,3x80 for frame
No. K500E0007

Technische Änderungen vorbehalten. Andere Farben auf Anfrage.
Sous réserve de modifications techniques. Autres teintes sur demande.
Right to alter technical details reserved. Other colours available on request.



EINSTELLANLEITUNG

Notice de réglage
Adjustment instructions



Höhenverstellung · Réglage en hauteur · Adjusting the height

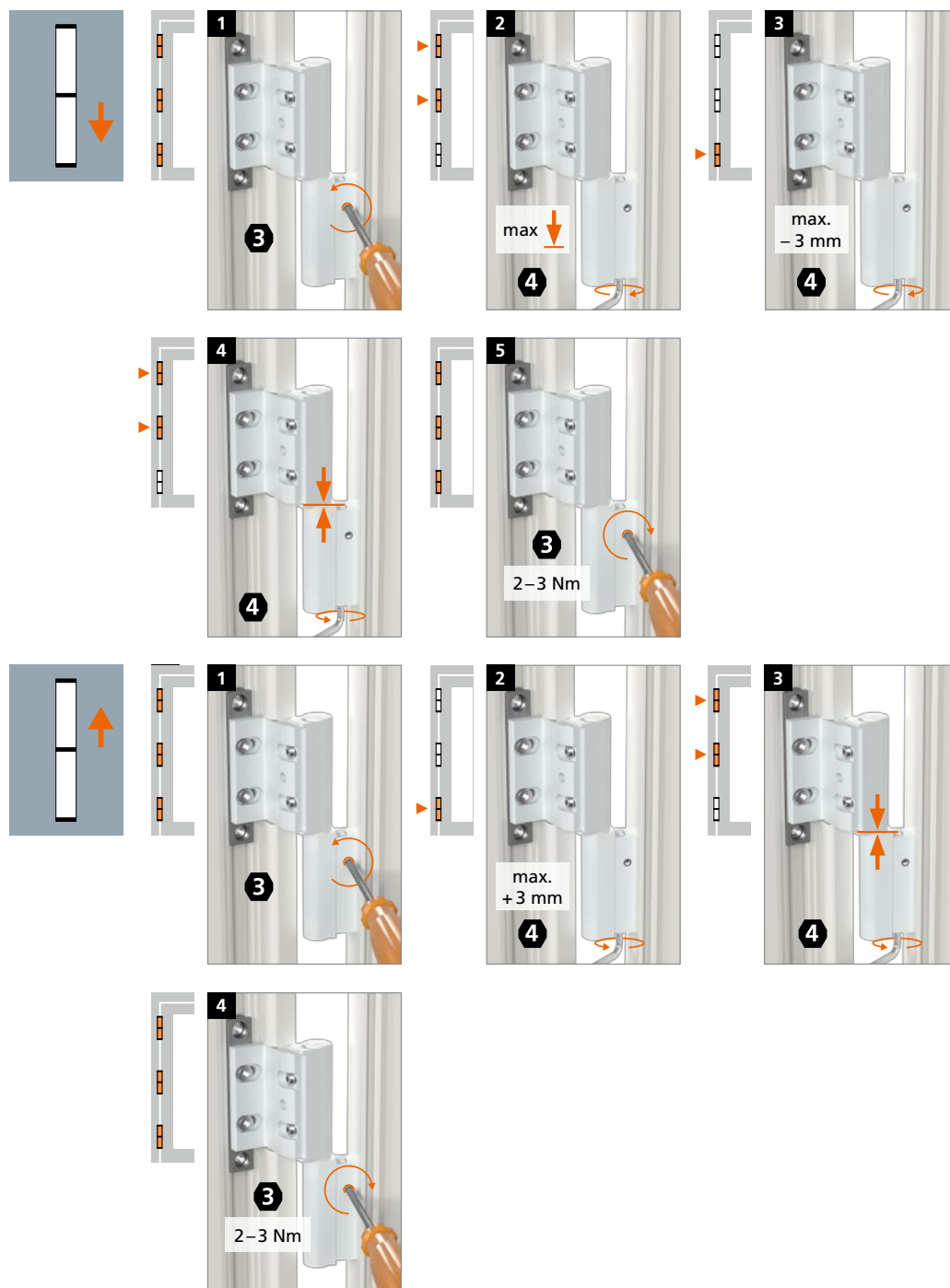



EINSTELLANLEITUNG

Notice de réglage
Adjustment instructions



Horizontalverstellung · Réglage horizontal · Horizontal adjustment

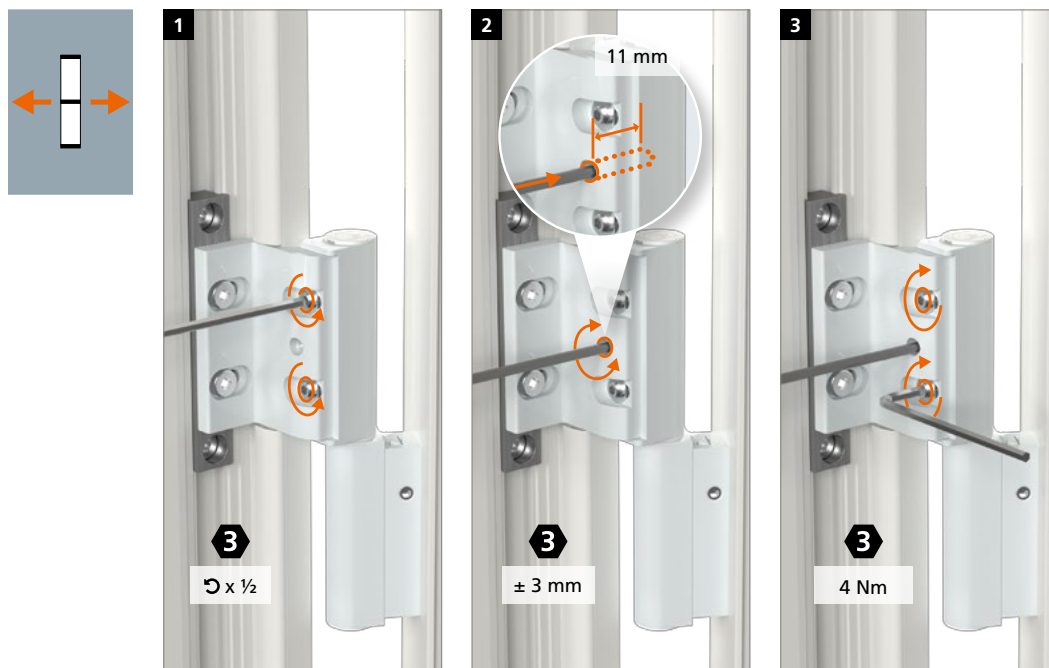

Dichtungsandruckverstellung · Réglage de la compression du joint d'étanchéité · Adjusting the sealing pressure

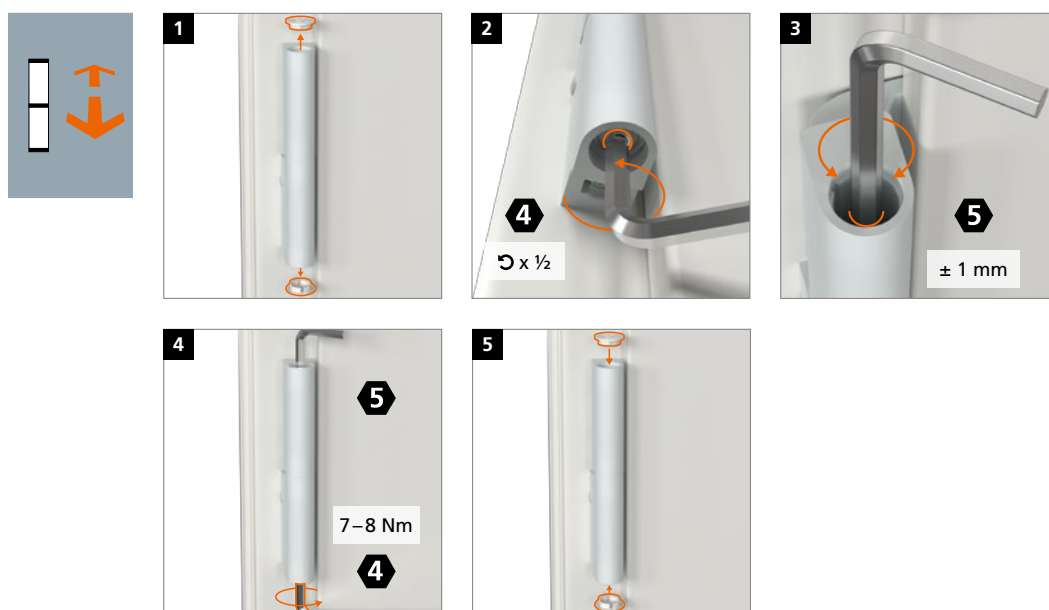



Hahn Serie 60 AT



Hahn KT-EV



Hahn VL-Band ST



Hahn Rollenband G



Hahn KT-RV



*Für jede
Situation
die passende
Lösung*



Hahn KT-V 6R



Hahn VL-Band 180



Hahn Rollenband NG



Hahn KT-RN



Hahn Türband 4 AT



Hahn KT-Rollenband NL



Hahn KT-SV



Hahn KT-B 6R



Hahn Türband 4 AT



Hahn KT-N 6R



Hahn Türband 4 HM0



Hahn KT-RKN



Hahn KT-RV



Hahn KT-EN



Hahn Rollenband AT



Hahn Serie 60 AT



Hahn VL-Band AT



Hahn Klemmband



Hahn KT-RKV



Hahn Klemmband



Hahn AT-G



Hahn KT-RN

 **Dr. Hahn**[®]
TÜRBÄNDER. MADE IN GERMANY.



Dr. Hahn GmbH & Co. KG

Trompeterallee 162-170 · D-41189 Mönchengladbach
Postfach 400109 · D-41181 Mönchengladbach
Phone +49(0)2166 954-3 · E-Mail: sales@dr-hahn.com
www.dr-hahn.eu